

## Main Switches and Maintenance Switches

Switch Disconnectors of the KG and KH series

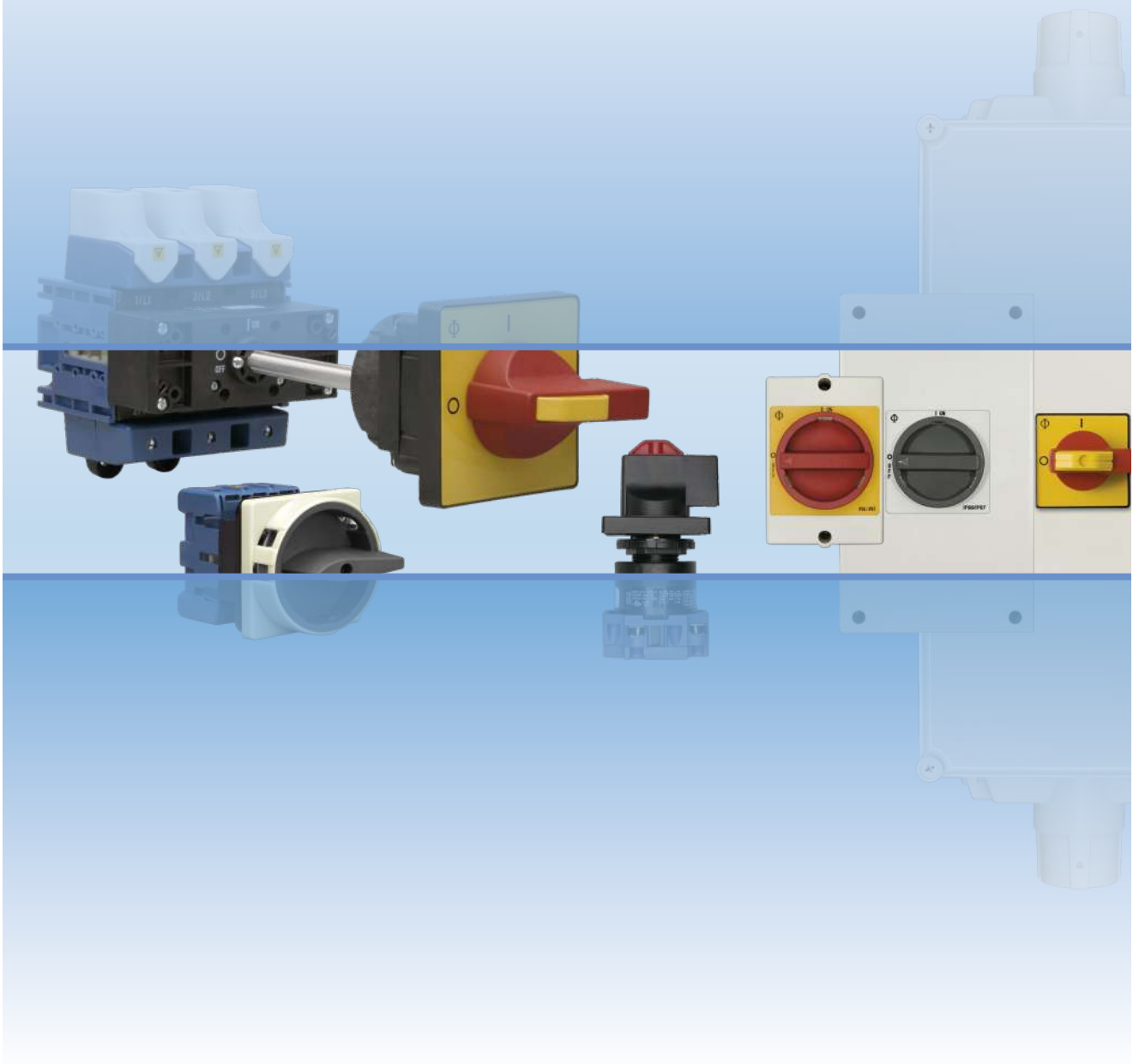

---

# Kraus & Naimer

The development of the Blue Line rotary switch and motor starter product ranges is based on more than hundred years experience by Kraus & Naimer in the design and manufacture of electrical switchgear. Kraus & Naimer pioneered the introduction of the cam operated rotary switch and continues to be recognized as the world leader in that product field.

## BLUE LINE

Blue Line products are protected by numerous patents through-out the industrial world. They are built to national and international standards and designed to withstand adverse temperatures and climates.

Blue Line products are accepted and universally recognized for their quality and workmanship. They are supported by a worldwide sales and service organization.

The Kraus & Naimer Registered Trademark

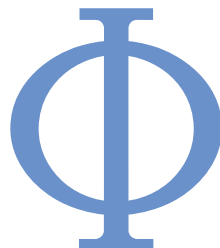

WORLDWIDE SYMBOL  
FOR QUALITY SWITCHGEAR

---

---

<b>Contents</b>	<b>Page</b>
<hr/>	
<b>Miscellaneous</b>	
Construction Data	4
Selection of the Main Switches	4
Standard Equipment	4
Mounting Units	5
Technical Data	6, 7
Lateral mounted Auxiliary Contacts, Protective Covers	36
Add-on Escutcheon Plates	37
Terminals for Control Circuit, Unlock Insert, Mounting Key	38
Connecting Diagrams	39
<hr/>	
<b>Main Switches and Main Switches with Emergency Function</b>	
2 and 3 pole	8-11
4 pole	12-15
3 pole with Ground and Neutral Terminal	16-19
3 pole and Auxiliary Contact	20-23
3 pole and 2 Auxiliary Contacts	24-27
<hr/>	
<b>Maintenance and Safety Switches</b>	
(Main Switches and Main Switches with Emergency Function in Plastic Enclosure)	
3 pole	28
3 pole and Auxiliary Contacts	29
4 pole	30
4 pole and Auxiliary Contacts	31
6 pole	32
6 pole and Auxiliary Contacts	33
<hr/>	
<b>Switch Disconnectors</b>	
3 pole	34, 35
3 pole with Ground Terminal	35
3 pole with Neutral Terminal	35
4 pole	36
6 pole	36
8 pole	36
2 pole (Double-throw Switches)	38
3 pole (Double-throw Switches)	38
4 pole (Double-throw Switches)	38
<hr/>	
<b>Switch Disconnectors in Plastic Enclosure</b>	
3, 4, and 6 pole	39
<hr/>	
<b>Dimensions</b>	
Switches for Panel Mounting	44
Switches for Base Mounting	45
Switches in Plastic Enclosure	46
<hr/>	
<b>Blue Line Switchgear:</b>	
<b>Summary</b>	<b>50</b>
<hr/>	
<b>Main Switches with 4 poles and also Maintenance Switches with 6 poles and more on request.</b>	
<hr/>	

Switch disconnectors of the KG-series



Switch disconnectors of the KH-series



Main switches of the KG- and KH-series  
2 designs



Main switches C316



Maintenance and safety switches  
2 designs



## Construction Data

The switches described in this catalog exceed the requirements of IEC 60947-3, EN 60947-3, VDE 0660 part 107, IEC 60204, EN 60204 and VDE 0113 and meet the standard on switch disconnectors, main switches and maintenance switches.

Common characteristics of the modular switch line KG and KH are:

High circuit withstand capability and greater air and creepage distances for circuits up to 1000 V resp. 690 V. Positive contact movement during making and breaking operations.

Base mounted switches up to 100 A are designed for standard rail mounting in accordance with EN 50022. For ease of installation, switch terminations are on the same plane as the power conductors and are supplied with open terminals. Captive plus-minus terminal screws and integrated screwdriver guides also reduce wiring time.

Terminals on the KG10 through KG160 and the KH-series are all finger-proof in accordance with EN 50274, VDE 0660 part 514 and BGV A3, with additional protection IP 20 (all-around finger-proof) on the KG10 through KG64 resp. KH40.

The switches of the KH-series are also available with adjustable length through shaft and for connecting with ring type terminals. KG125, KG160, KG210, KG250 and KG315 can be supplied with bolt terminals either on top or with terminals on the top and bottom.

C type switches used as main switches require a protective cover for the outgoing and incoming terminals.

Enclosures for the C and KG type switches are made of a strong durable plastic with high UV-resistance and are designed with extra space for easy wiring. A special enclosure series which is suitable for applications in an aggressive environment, such as oil, chemical substances and grease is also available.

## Selection of the Main Switches

The regulations of VDE 0113 part 1 resp. EN 60204-1 indicate a difference between switch disconnectors and disconnectors when selecting the main switch.

Switch disconnectors have to conform to category AC-23B. The disconnector must have an auxiliary contact which ensures the load interruption by means of contactor. The disconnector, therefore, should be selected according to the thermal current of the load. The auxiliary contact must have a sufficient AC-15 switching capacity to operate the contactor.

When using the switch disconnector as a main switch the breaking capacity of the switch has to be considered. The interruption capacity of the switch must equal or exceed the locked rotor current of the machine's largest motor plus the total current of all other electrical equipment in the circuit. In addition, the total nominal current of all electrical equipment may not exceed the rated thermal current of the switch.

## Standard Equipment

Main Switches and Main Switches with Emergency Function:

Are supplied with a padlockable handle and protective cover for all the incoming terminals for switch types C316, KG80 through KG315, KH63 and KH80. Switch types C316, KG210, KG250 and KG315 are also supplied with protective covers on the outgoing terminals.

Main switches are fitted with black handles. Main switches with emergency function are supplied with red handles and contrasting yellow escutcheon plate.

Switches with door clutches are also supplied with a padlock device.

Maintenance and Safety Switches (Main Switches and Main Switches with Emergency Function in Enclosure):

High strength durable plastic enclosures are designed with extra space for easy wiring (see Construction Data), totally insulated acc. to IEC 364-4-41, HD 384.4.41 S2 and VDE 0100-410. All KL- and KS-enclosures are flame resistant in accordance with UL94V-0.

Main switches are fitted with electro-gray or black handles. Main switches with emergency function are supplied with red handles and contrasting yellow escutcheon plate.

Ground terminal.

Special safety interlocked covers supplied with enclosures.

Switches with code numbers ending with STM are supplied with conduit entries.





Notes:

Auxiliary contacts close after the main contacts close and open before main contacts open. A selection of padlock devices are shown on page 5.

Main switches with 4 poles and also maintenance switches with 6 poles and more on request.

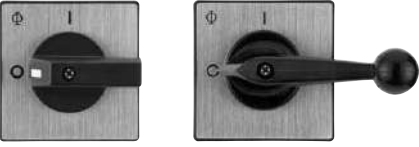
## Ordering Information

Ordering information is shown in blue on pages 8-37.

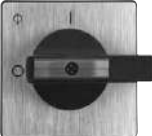
<b>Mounting Units</b> Switch disconnectors Main switches and main switches with emergency function with padlock device	<b>Size</b> in mm	<b>Padlocks</b> Max. Pad-lock    Shackle in mm		<b>Standard for Switch Types</b> Further variations on request.
 <p style="text-align: center;">KG210, KG250, KG315</p>	48 x 48  64 x 64  88 x 88 130 x 130	–    –  –    –  –    – –    –	Four hole panel mounting, base mounting <b>KG10A, KG 20A, KG32A, KG41, KG64, KH16, KH20, KH25</b> Single hole mounting 22 mm <b>KG10A, KG20A, KG32A, KH16, KH20, KH25</b> Direct-mounting on printed circuit board <b>KG21A, KG33A</b> Four hole panel mounting, base mounting <b>KG10B, KG20B, KG32B, KG41B, KG64B, KG80, KG100, KH16B, KH20B, KH25B, KH32, KH40, KH63, KH80</b> <b>KG80C, KG100C, KG125, KG160, KG210, KG250, KG315 C316</b>	
	74 x 74	3    9	In enclosure <b>KG10, KG20, KG20B, KG32, KG32B, KG41, KG41B, KG64, KG64B, KG80, KG100</b> <b>KH16, KH20, KH25, KH32, KH40, KH63, KH80</b>	
	64 x 64  88 x 88	3    9  3    10	Four hole panel mounting, base mounting <b>KG10B, KG20B, KG32B, KG41B, KG64B, KG80, KG100, KH16B, KH20B, KH25B, KH32, KH40, KH63, KH80</b> Single hole mounting 22 mm <b>KG10B, KG20B, KG32B, KH16, KH20, KH25, KH32, KH40</b>  Four hole panel mounting <b>KG80C, KG100C, KG125, KG160</b> Base mounting <b>KG125, KG160</b> In enclosure <b>KG80C, KG100C, KG125, KG160</b>	
	48 x 48  64 x 64  88 x 88  130 x 130	3    7 or 4    5  3    8 or 4    5  4    9  4    9	Four hole panel mounting, base mounting <b>KG10A, KG20A, KG32A, KG41, KG64, KH16, KH20, KH25</b> Single hole mounting 22 mm <b>KG10A, KG20A, KG32A, KH16, KH20, KH25</b>  Four hole panel mounting or Single hole mounting 22 mm, base mounting <b>KG10B, KG20B, KG32B, KG41B, KG64B, KG80, KG100, KH16B, KH20B, KH25B, KH32, KH40, KH63, KH80</b> In enclosure <b>KG10, KG20, KG20B, KG32, KG32B, KG41, KG41B, KG64, KG64B, KG80, KG100</b>  Four hole panel mounting <b>KG80C, KG100C, KG125, KG160, KG210, KG250, KG315</b> <b>KG41B T..3/81 E, KG64B T..3/81 E</b> In enclosure <b>KG80C, KG100C, KG125, KG160, KG250, KG315</b> Four hole panel mounting and in enclosure <b>C316</b>	
	88 x 88	4    9	Four hole panel mounting <b>KG250, KG315</b>	
	88 x 88	3    9	Base mounting <b>KG20B, KG32B, KG41B, KG64B, KG80, KG100, KG125, KG160, KG210, KG250, KG315, KH32, KH40, KH63, KH80, C316</b>  With integrated door clutch. Using the device the electrical panel may be opened only when the switch is in the OFF position and no padlock is fitted. Note: Only in the ON position can knowledgeable personnel using a simple tool to defeat the interlock. The M700's flexibility allows for successful installation with as much as + or – 5 mm of misalignment between the shaft and door.	



<b>Technical Data in accordance with</b> <b>IEC 60947-3, EN 60947-3, VDE 0660 part 107,</b> <b>IEC 60204, EN 60204, VDE 0113</b>  Nominal ratings for North America (UL) see Catalog 150 <sup>5</sup> .			KG10 KG10A KG10B	KH16 KH16B	KG20 KG20A KG20B	KH20 KH20B	KH25 KH25B	KG32 KG32A KG32B	KH32	KG41 KG41B
<b>Rated Values</b>										
Insulation voltage $U_i^1$	V	690 <sup>8</sup>	800 <sup>2</sup>	690	800 <sup>2</sup>	800 <sup>2</sup>	690	800 <sup>2</sup>	690	
min. voltage	V				on request					
Impulse withstand voltage $U_{imp}^1$	kV	4	6	6	6	6	6	6	6	
Thermal current	$I_{u\ open} = I_{th}$	20	16	25	20	25	32	32	40	
	$I_{the\ enclosed}$	20	16	25	20	25	32	32	40	
Breaking capacity	220 V/240 V	120	160	180	200	250	220	300	300	
	380 V/440 V	120	160	180	200	250	220	300	300	
	660 V/690 V	80	160	125	160	180	135	210	150	
<b>Main Switch Voltage Rating</b>										
Disconnection property up to <sup>1</sup>	V	690 <sup>8</sup>	690	690	690	690	690	690	690	
<b>Utilization Category</b>										
AC-21A Switch disconnectors for resistive load $I_e$	A	20	16	25	20	25	32	32	40	
AC-3 Direct switching of single motors	<b>3 phase, 3 pole</b>									
	220 V/240 V	kW	2,2	3	4	3,5	4	5,5	5,5	7,5
	380 V/440 V	kW	3,7	5,5	5,5	6,5	7,5	7,5	11	11
	660 V/690 V	kW	3,7	5,5	5,5	6,5	7,5	7,5	11	11
	<b>1 phase, 2 pole</b>									
	220 V/240 V	kW	1,1	1,5		2	2,5		3	
380 V/440 V	kW	1,5	2,5		3,2	5		5,5		
AC-23A, Switch disconnectors for motor circuits, main switches etc.	<b>3 phase, 3 pole</b>									
	220 V/240 V	kW	3	4,5	5,5	5,5	7	5,5	9	7,5
	380 V/440 V	kW	5,5	7,5	7,5	10	12	11	16	15
	660 V/690 V	kW	5,5	13	7,5	15	17	11	22	15
	<b>1 phase, 2 pole</b>									
	220 V/240 V	kW	1,5	2		2,5	3,3		4,2	
380 V/440 V	kW	2,2	3,7		4,5	5,5		7,5		
Power loss per contact at $I_u$	W	0,9	0,2	0,7	0,3	0,3	1,1	0,4	1	
Resistance to vibration <sup>7</sup>	C	C	C	A	C	C	A	C	A	
Resistance to shock <sup>7</sup>	C	C	C	B	C	C	B	C	B	
<b>Short Circuit Protection</b>										
Max. fuse size (gL-characteristic)	A	20	25	35	35	35	35	35	50	
Rated short-time withstand current (1s-current)	A	130	400	350	450	500	430	850	500	
<b>Max. Permissible Wire Gage<sup>6</sup></b>										
Single-core or stranded wire	mm <sup>2</sup>	2,5	6	6	6	6	6	10	16	
	AWG	12	10	10	10	10	10	8	6	
	MCM	–	–	–	–	–	–	–	–	
Flexible wire with sleeve	mm <sup>2</sup>	2,5	4	4	4	4	4	6	10	
	AWG	12	12	10	12	12	10	10	6	
Flexible AWG wires (without sleeve)	MCM	–	–	–	–	–	–	–	–	
	mm	–	–	–	–	–	–	–	–	
Connecting bolts	mm	–	–	–	–	–	–	–	–	
Flat copper busbar	mm	–	–	–	–	–	–	–	–	
<b>Auxiliary Contacts Rated Values</b>										
Insulation voltage $U_i^1$	V	690 <sup>8</sup>	440	500	440	440	500	440	690	
Impulse withstand voltage $U_{imp}^1$	kV	4 <sup>8</sup>	4	6	4	4	6	4	6	
Thermal current	$I_{u\ open} = I_{th}$	20	10	10	10	10	10	10	16	
	$I_{the\ enclosed}$	20	10	10	10	10	10	10	16	
AC-15 Operational current $I_e$	220 V/240 V	A	6	2,5	2,5	2,5	2,5	2,5	6	
	380 V/440 V	A	4	1,5	1,5	1,5	1,5	1,5	3	
<b>Short Circuit Protection</b>										
Max. fuse size (gL-characteristic)	A	20	10	10	10	10	10	10	16	
<b>Max. Permissible Wire Gage<sup>6</sup></b>										
Single-core or stranded wire	mm <sup>2</sup>	2,5	1,5	1,5	1,5	1,5	1,5	1,5	2,5	
	AWG	12	14	14	14	14	14	14	12	
Flexible wire with sleeve	mm <sup>2</sup>	2,5	1,5	1,5	1,5	1,5	1,5	1,5	2,5	
	AWG	12	16	16	16	16	16	16	14	

<sup>1</sup>Valid for lines with grounded common neutral termination, overvoltage category III, pollution degree 3. Values for other supply systems on request.  
<sup>2</sup>Suitable for no load switching applications (AC-20A) above 690 V. <sup>3</sup>The value after the slash is valid for switches 6 pole. <sup>4</sup>Connecting for cable lug.

KH40	KG64 KG64B	KH63	KG80 KG80C	KH80	KG100 KG100C	KG125	KG160	KG210	KG250	KG315	C316
800 <sup>2</sup>	690	1000 <sup>2</sup>	690	1000 <sup>2</sup>	690	1000 <sup>2</sup>	1000 <sup>2</sup>	1000 <sup>2</sup>	1000 <sup>2</sup>	1000 <sup>2</sup>	1000
6	6	8	6	8	6	8	8	8	8	8	8
40	63	63	80	80	100	125	160	200	250	315	315
40	63	63	80	80	100	125	160	200	250	315	315/275 <sup>3</sup>
380	350	550	560	650	700	800	900	1300	1600	1800	2000
380	350	500	560	630	650	750	850	1100	1380	1650	2000
230	190	280	200	340	280	340	340	400	400	400	335
690	690	1000 <sup>2</sup>	690	1000 <sup>2</sup>	690	1000 <sup>2</sup>	1000 <sup>2</sup>	1000 <sup>2</sup>	1000 <sup>2</sup>	1000 <sup>2</sup>	1000
40	63	63	80	80	100	125	160	200	250	315	315
7,5	11	11	15	15	18,5	22	30	37	37	45	37
15	18,5	22	22	30	30	37	45	55	55	75	55
15	15	18,5	18,5	22	22	30	37	40	40	45	37
4,5		7,5		10							
9		11		15							
11	11	18,5	18,5	23	22	30	30	37	37	55	75
20	22	30	30	40	37	45	55	75	90	110	132
25	18,5	30	22	37	30	37	37	45	45	45	37
5,5		8,5		11							
11		15		18,5							
0,6	2,2	1,5	1,7	2,7	2,4	3,1	5	5	8	12,7	17
C	A	C	A	C	A	C	C	C	C	C	C
C	B	C	B	C	B	C	C	C	C	C	C
50	63	80	80	100	100	125	160	200	250	315	315
950	580	1200	1600	1600	1850	2500	3000	4000	4600	5800	4200
10	16	35	50	35	50	95	95	185	185	185	185 <sup>4</sup>
8	6	2	1/0	2	1/0	3/0	3/0	–	–	–	–
–	–	–	–	–	–	–	–	350	350	350	350
6	10	25	35	25	35	70	70	120	120	120	150 <sup>4</sup>
10	6	4	2	4	2	1/0	1/0	–	–	–	–
–	–	–	–	–	–	–	–	250	250	250	300
–	–	–	–	–	–	–	–	–	–	–	M12
–	–	–	–	–	–	–	–	–	–	–	–
440	690	440	690	440	690	690	690	690	690	690	690
4	6	4	6	4	6	6	6	6	6	6	6
10	16	10	16	10	16	16	16	16	16	16	16
10	16	10	16	10	16	16	16	16	16	16	16
2,5	6	2,5	6	2,5	6	6	6	6	6	6	6
1,5	3	1,5	3	1,5	3	3	3	3	3	3	4
10	16	10	16	10	16	16	16	16	16	16	16
1,5	2,5	1,5	2,5	1,5	2,5	2,5	2,5	2,5	2,5	2,5	4
14	12	14	12	14	12	12	12	12	12	12	12
1,5	2,5	1,5	2,5	1,5	2,5	2,5	2,5	2,5	2,5	2,5	2,5
16	14	16	14	16	14	14	14	14	14	14	14

<sup>5</sup>The switches of the KG- and KH-series shown in this catalog are approved by UL and CSA as „disconnect switches for use in motor circuits“. Exception: Switches in enclosure. <sup>6</sup>Use copper wire only. A: min. 4 g, 2-100 Hz, 1,6 mm. B: min. 5 g, 6 ms. C: on request. <sup>8</sup>Valid for lines with grounded common neutral termination, overvoltage category II, pollution degree 3. Storage temperature for all switch types: -40 °C to 85 °C (in case of temperature below -5 °C no shock load permissible).

## Main Switches and Main Switches with Emergency Function 2 and 3 pole, for Four Hole Panel Mounting

Version	Thermal Current $I_U/I_{th}$	Ratings AC-23A, AC-23B Breaking Capacity	Main Switches Handle black	EAN-Code 9004257	Main Switches with Emergency Function Handle red Contrasting yellow plate	EAN-Code 9004257	
IP 66 64 x 64  	20 A	<b>220 V/240 V</b> 1,5 kW / 120 A	<b>2 pole</b> KG10B T102/01 E	01367 8	<b>2 pole</b> KG10B T202/01 E	01375 3	
	20 A	<b>3 x 380 V/440 V</b> 5,5 kW / 120 A	<b>3 pole</b> KG10B T103/01 E	01044 8	<b>3 pole</b> KG10B T203/01 E	01049 3	
	25 A	7,5 kW / 180 A	KG20B T103/01 E	00001 2	KG20B T203/01 E	00043 2	
	32 A	11 kW / 220 A	KG32B T103/01 E	00002 9	KG32B T203/01 E	00044 9	
	40 A	15 kW / 300 A	KG41B T103/01 E	00003 6	KG41B T203/01 E	00045 6	
	63 A	22 kW / 350 A	KG64B T103/01 E	00004 3	KG64B T203/01 E	00046 3	
	80 A	30 kW / 560 A	KG80 T103/01 E	00005 0	KG80 T203/01 E	00047 0	
	100 A	37 kW / 650 A	KG100 T103/01 E	00006 7	KG100 T203/01 E	00048 7	
	88 x 88	80 A	30 kW / 560 A	KG80C T103/01 E	01383 8	KG80C T203/01 E	01389 0
		100 A	37 kW / 650 A	KG100C T103/01 E	01384 5	KG100C T203/01 E	01390 6
125 A		45 kW / 750 A	KG125 T103/01 E	00008 1	KG125 T203/01 E	00050 0	
160 A		55 kW / 850 A	KG160 T103/01 E	00009 8	KG160 T203/01 E	00051 7	
IP 66 <sup>1</sup> 48 x 48  	20 A	<b>220 V/240 V</b> 1,5 kW / 120 A	<b>2 pole</b> KG10A T102/04 E	01368 5	<b>2 pole</b> KG10A T202/04 E	01376 0	
	20 A	<b>3 x 380 V/440 V</b> 5,5 kW / 120 A	<b>3 pole</b> KG10A T103/04 E	01046 2	<b>3 pole</b> KG10A T203/04 E	01051 6	
	25 A	7,5 kW / 180 A	KG20A T103/04 E	01110 0	KG20A T203/04 E	01132 2	
	32 A	11 kW / 220 A	KG32A T103/04 E	01111 7	KG32A T203/04 E	01133 9	
	40 A	15 kW / 300 A	KG41 T103/04 E	01112 4	KG41 T203/04 E	01134 6	
	63 A	22 kW / 350 A	KG64 T103/04 E	01113 1	KG64 T203/04 E	01135 3	
	64 x 64	20 A	<b>220 V/240 V</b> 1,5 kW / 120 A	<b>2 pole</b> KG10B T102/04 E	01369 2	<b>2 pole</b> KG10B T202/04 E	01377 7
		20 A	<b>3 x 380 V/440 V</b> 5,5 kW / 120 A	<b>3 pole</b> KG10B T103/04 E	01047 9	<b>3 pole</b> KG10B T203/04 E	01052 3
		25 A	7,5 kW / 180 A	KG20B T103/04 E	01114 8	KG20B T203/04 E	01136 0
		32 A	11 kW / 220 A	KG32B T103/04 E	01115 5	KG32B T203/04 E	01137 7
40 A		15 kW / 300 A	KG41B T103/04 E	01116 2	KG41B T203/04 E	01138 4	
63 A		22 kW / 350 A	KG64B T103/04 E	01117 9	KG64B T203/04 E	01139 1	
80 A		30 kW / 560 A	KG80 T103/04 E	01118 6	KG80 T203/04 E	01140 7	
100 A		37 kW / 650 A	KG100 T103/04 E	01119 3	KG100 T203/04 E	01141 4	
88 x 88	40 A	15 kW / 300 A	KG41B T103/81 E	03170 2	KG41B T203/81 E	03172 6	
	63 A	22 kW / 350 A	KG64B T103/81 E	03171 9	KG64B T203/81 E	03173 3	
	80 A	30 kW / 560 A	KG80C T103/04 E	00021 0	KG80C T203/04 E	00063 0	
	100 A	37 kW / 650 A	KG100C T103/04 E	00022 7	KG100C T203/04 E	00064 7	
	125 A	45 kW / 750 A	KG125 T103/04 E	00024 1	KG125 T203/04 E	00066 1	
	160 A	55 kW / 850 A	KG160 T103/04 E	00025 8	KG160 T203/04 E	00067 8	
	200 A	75 kW / 1100 A	KG210 T103/05 E	07491 4	KG210 T203/05 E	07484 6	
	250 A	90 kW / 1380 A	KG250 T103/05 E	00027 2	KG250 T203/05 E	00069 2	
	315 A	110 kW / 1650 A	KG315 T103/05 E	00028 9	KG315 T203/05 E	00070 8	
	130 x 130	315 A	132 kW / 2000 A	C316 T103/05 E	00029 6	C316 T203/05 E	00071 5

[< back to table of contents >](#)



<sup>1</sup>C316 protection IP 40. Higher protection available on request.



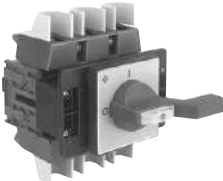

## Main Switches and Main Switches with Emergency Function 3 pole, for Four Hole Panel Mounting

Version	Thermal Current $I_u/I_{th}$	Ratings AC-23A, AC-23B Breaking Capacity 3 x 380 V/440 V	Main Switches Handle black	EAN-Code 9004257	Main Switches with Emergency Function Handle red Contrasting yellow plate	EAN-Code 9004257
IP 66 88 x 88 	250 A 315 A	90 kW / 1380 A 110 kW/1650 A	KG250 T103/66 E KG315 T103/66 E	01276 3 01277 0	KG250 T203/66 E KG315 T203/66 E	01278 7 01279 4



## Main Switches and Main Switches with Emergency Function 2 and 3 pole, for Single Hole Mounting 22 mm

Version	Thermal Current $I_u/I_{th}$	Ratings AC-23A, AC-23B Breaking Capacity	Main Switches Handle black	EAN-Code 9004257	Main Switches with Emergency Function Handle red Contrasting yellow plate	EAN-Code 9004257
IP 66 64 x 64 	20 A 20 A 25 A 32 A	<b>220 V/240 V</b> 1,5 kW / 120 A  <b>3 x 380 V/440 V</b> 5,5 kW / 120 A 7,5 kW / 180 A 11 kW / 220 A	<b>2 pole</b> KG10B T102/01 FT2  <b>3 pole</b> KG10B T103/01 FT2 KG20B T103/01 FT2 KG32B T103/01 FT2	01372 2  01048 6 00085 2 00086 9	<b>2 pole</b> KG10B T202/01 FT2  <b>3 pole</b> KG10B T203/01 FT2 KG20B T203/01 FT2 KG32B T203/01 FT2	01380 7  01053 0 00089 0 00090 6
IP 66 48 x 48   64 x 64	20 A 20 A 25 A 32 A  20 A 20 A 25 A 32 A	<b>220 V/240 V</b> 1,5 kW / 120 A  <b>3 x 380 V/440 V</b> 5,5 kW / 120 A 7,5 kW / 180 A 11 kW / 220 A  <b>220 V/240 V</b> 1,5 kW / 120 A  <b>3 x 380 V/440 V</b> 5,5 kW / 120 A 7,5 kW / 180 A 11 kW / 220 A	<b>2 pole</b> KG10A T102/04 FT2  <b>3 pole</b> KG10A T103/04 FT2 KG20A T103/04 FT2 KG32A T103/04 FT2  <b>2 pole</b> KG10B T102/04 FT2  <b>3 pole</b> KG10B T103/04 FT2 KG20B T103/04 FT2 KG32B T103/04 FT2	01370 8  01054 7 01130 8 01131 5  01371 5  01055 4 01056 1 01057 8	<b>2 pole</b> KG10A T202/04 FT2  <b>3 pole</b> KG10A T203/04 FT2 KG20A T203/04 FT2 KG32A T203/04 FT2  <b>2 pole</b> KG10B T202/04 FT2  <b>3 pole</b> KG10B T203/04 FT2 KG20B T203/04 FT2 KG32B T203/04 FT2	01378 4  01072 1 01152 0 01153 7  01379 1  01073 8 01074 5 01075 2



## Main Switches and Main Switches with Emergency Function 2 and 3 pole, for Base Mounting with Simplified Door Clutch, Padlock Device and Single Hole Mounting 22 mm

Version	Thermal Current $I_U/I_{th}$	Ratings AC-23A, AC-23B Breaking Capacity	Main Switches	EAN-Code	Main Switches with Emergency Function	EAN-Code	
Protection Escutcheon plate in mm			Handle black	9004257	Handle red Contrasting yellow plate	9004257	
IP 66 48 x 48  	20 A	<b>220 V/240 V</b> 1,5 kW / 120 A	<b>2 pole</b> KG10A T102/68 VE	01373 9	<b>2 pole</b> KG10A T202/68 VE	01381 4	
	20 A	<b>3 x 380 V/440 V</b> 5,5 kW / 120 A	<b>3 pole</b> KG10A T103/68 VE	01060 8	<b>3 pole</b> KG10A T203/68 VE	01078 3	
	25 A	7,5 kW / 180 A	KG20A T103/68 VE	01061 5	KG20A T203/68 VE	01079 0	
	32 A	11 kW / 220 A	KG32A T103/68 VE	01062 2	KG32A T203/68 VE	01080 6	
	40 A	15 kW / 300 A	KG41 T103/68 VE	01063 9	KG41 T203/68 VE	01081 3	
	63 A	22 kW / 350 A	KG64 T103/68 VE	01064 6	KG64 T203/68 VE	01082 0	
	64 x 64	20 A	<b>220 V/240 V</b> 1,5 kW / 120 A	<b>2 pole</b> KG10B T102/68 VE	01374 6	<b>2 pole</b> KG10B T202/68 VE	01382 1
		20 A	<b>3 x 380 V/440 V</b> 5,5 kW / 120 A	<b>3 pole</b> KG10B T103/68 VE	01065 3	<b>3 pole</b> KG10B T203/68 VE	01083 7
		25 A	7,5 kW / 180 A	KG20B T103/68 VE	01066 0	KG20B T203/68 VE	01084 4
		32 A	11 kW / 220 A	KG32B T103/68 VE	01067 7	KG32B T203/68 VE	01085 1
		40 A	15 kW / 300 A	KG41B T103/68 VE	01068 4	KG41B T203/68 VE	01086 8
		63 A	22 kW / 350 A	KG64B T103/68 VE	01069 1	KG64B T203/68 VE	01087 5
80 A		30 kW / 560 A	KG80 T103/68 VE	01070 7	KG80 T203/68 VE	01088 2	
100 A	37 kW / 650 A	KG100 T103/68 VE	01071 4	KG100 T203/68 VE	01089 9		
IP 66 64 x 64   <p>Misalignment between the shaft and operator is compensated for by a centering device.</p>	20 A	<b>3 x 380 V/440 V</b> 5,5 kW / 120 A	<b>3 pole</b> KG10B T103/93 VE	06347 5	<b>3 pole</b> KG10B T203/93 VE	06354 3	
	25 A	7,5 kW / 180 A	KG20B T103/93 VE	06348 2	KG20B T203/93 VE	06355 0	
	32 A	11 kW / 220 A	KG32B T103/93 VE	06349 9	KG32B T203/93 VE	06356 7	
	40 A	15 kW / 300 A	KG41B T103/93 VE	06350 5	KG41B T203/93 VE	06357 4	
	63 A	22 kW / 350 A	KG64B T103/93 VE	06351 2	KG64B T203/93 VE	06358 1	
	80 A	30 kW / 560 A	KG80 T103/93 VE	06352 9	KG80 T203/93 VE	06359 8	
	100 A	37 kW / 650 A	KG100 T103/93 VE	06353 6	KG100 T203/93 VE	06360 4	
	IP 66 64 x 64   <p>Misalignment between the shaft and operator is compensated for by a centering device.</p>	20 A	<b>3 x 380 V/440 V</b> 5,5 kW / 120 A	<b>3 pole</b> KG10B T103/94 VE	06361 1	<b>3 pole</b> KG10B T203/94 VE	06368 0
		25 A	7,5 kW / 180 A	KG20B T103/94 VE	06362 8	KG20B T203/94 VE	06369 7
		32 A	11 kW / 220 A	KG32B T103/94 VE	06363 5	KG32B T203/94 VE	06370 3
40 A		15 kW / 300 A	KG41B T103/94 VE	06364 2	KG41B T203/94 VE	06371 0	
63 A		22 kW / 350 A	KG64B T103/94 VE	06365 9	KG64B T203/94 VE	06372 7	
80 A		30 kW / 560 A	KG80 T103/94 VE	06366 6	KG80 T203/94 VE	06373 4	
100 A		37 kW / 650 A	KG100 T103/94 VE	06367 3	KG100 T203/94 VE	06374 1	

## Main Switches and Main Switches with Emergency Function 3 pole, for Base Mounting with Door Clutch

Version	Thermal Current $I_u/I_{th}$	Ratings AC-23A, AC-23B Breaking Capacity 3 x 380 V/440 V	Main Switches Handle black	EAN-Code 9004257	Main Switches with Emergency Function Handle red Contrasting yellow plate	EAN-Code 9004257
IP 66/67 64 x 64 	20 A 25 A 32 A 40 A 63 A 80 A 100 A	5,5 kW / 120 A 7,5 kW / 180 A 11 kW / 220 A 15 kW / 300 A 22 kW / 350 A 30 kW / 560 A 37 kW / 650 A	KG10B T103/09 VE KG20B T103/09 VE KG32B T103/09 VE KG41B T103/09 VE KG64B T103/09 VE KG80 T103/09 VE KG100 T103/09 VE	01280 0 00093 7 00094 4 00095 1 00096 8 00097 5 00098 2	KG10B T203/09 VE KG20B T203/09 VE KG32B T203/09 VE KG41B T203/09 VE KG64B T203/09 VE KG80 T203/09 VE KG100 T203/09 VE	01281 7 00107 1 00108 8 00109 5 00110 1 00111 8 00112 5
88 x 88	125 A 160 A	45 kW / 750 A 55 kW / 850 A	KG125 T103/09 VE KG160 T103/09 VE	00100 2 00101 9	KG125 T203/09 VE KG160 T203/09 VE	00114 9 00115 6
IP 66/67 48 x 48 	20 A 25 A 32 A	5,5 kW / 120 A 7,5 kW / 180 A 11 kW / 220 A	KG10A T103/65 VE KG20A T103/65 VE KG32A T103/65 VE	01058 5 01120 9 01121 6	KG10A T203/65 VE KG20A T203/65 VE KG32A T203/65 VE	01076 9 01142 1 01143 8
64 x 64	20 A 25 A 32 A 40 A 63 A 80 A 100 A	5,5 kW / 120 A 7,5 kW / 180 A 11 kW / 220 A 15 kW / 300 A 22 kW / 350 A 30 kW / 560 A 37 kW / 650 A	KG10B T103/65 VE KG20B T103/65 VE KG32B T103/65 VE KG41B T103/65 VE KG64B T103/65 VE KG80 T103/65 VE KG100 T103/65 VE	01059 2 01124 7 01125 4 01126 1 01127 8 01128 5 01129 2	KG10B T203/65 VE KG20B T203/65 VE KG32B T203/65 VE KG41B T203/65 VE KG64B T203/65 VE KG80 T203/65 VE KG100 T203/65 VE	01077 6 01146 9 01147 6 01148 3 01149 0 01150 6 01151 3
IP 66 88 x 88  <p>Using the device the electrical panel may be opened only when the switch is in the OFF position and no padlock is fitted. Note: Only in the ON position can knowledgeable personnel using a simple tool to defeat the interlock. The M700's flexibility allows for successful installation with as much as + or - 5 mm of misalignment between the shaft and door.</p>	25 A 32 A 40 A 63 A 80 A 100 A 125 A 160 A 200 A 250 A 315 A 315 A	7,5 kW / 180 A 11 kW / 220 A 15 kW / 300 A 22 kW / 350 A 30 kW / 560 A 37 kW / 650 A 45 kW / 750 A 55 kW / 850 A 75 kW / 1100 A 90 kW / 1380 A 110 kW / 1650 A 132 kW / 2000 A	KG20B T103/12 VE KG32B T103/12 VE KG41B T103/12 VE KG64B T103/12 VE KG80 T103/12 VE KG100 T103/12 VE KG125 T103/12 VE KG160 T103/12 VE KG210 T103/13 VE KG250 T103/13 VE KG315 T103/13 VE C316 T103/13 VE	01591 7 01592 4 00129 3 00130 9 00131 6 00132 3 00134 7 00135 4 07492 1 00137 8 00138 5 00139 2	KG20B T203/12 VE KG32B T203/12 VE KG41B T203/12 VE KG64B T203/12 VE KG80 T203/12 VE KG100 T203/12 VE KG125 T203/12 VE KG160 T203/12 VE KG210 T203/13 VE KG250 T203/13 VE KG315 T203/13 VE C316 T203/13 VE	01593 1 01594 8 00159 0 00160 6 00161 3 00162 0 00164 4 00165 1 07485 3 00167 5 00168 2 00169 9

## Main Switches and Main Switches with Emergency Function 4 pole, for Four Hole Panel Mounting

Version	Thermal Current $I_U/I_{th}$	Ratings AC-23A, AC-23B Breaking Capacity 3 x 380 V/440 V	Main Switches Handle black	EAN-Code 9004257	Main Switches with Emergency Function Handle red Contrasting yellow plate	EAN-Code 9004257	
IP 66 64 x 64  	16 A	7,5 kW / 160 A	KH16B T104/01 E	07091 6	KH16B T204/01 E	07094 7	
	20 A	10 kW / 200 A	KH20B T104/01 E	07092 3	KH20B T204/01 E	07095 4	
	25 A	12 kW / 250 A	KH25B T104/01 E	07093 0	KH25B T204/01 E	07096 1	
	32 A	16 kW / 300 A	KH32 T104/01 E	06510 3	KH32 T204/01 E	06511 0	
	40 A	20 kW / 380 A	KH40 T104/01 E	06512 7	KH40 T204/01 E	06513 4	
	63 A	30 kW / 500 A	KH63 T104/01 E	07493 8	KH63 T204/01 E	07486 0	
	80 A	40 kW / 630 A	KH80 T104/01 E	07494 5	KH80 T204/01 E	07487 7	
	100 A	37 kW / 650 A	KG100 T104/01 E	00186 6	KG100 T204/01 E	00228 3	
88 x 88	80 A	30 kW / 560 A	KG80C T104/01 E	01385 2	KG80C T204/01 E	01391 3	
	100 A	37 kW / 650 A	KG100C T104/01 E	01386 9	KG100C T204/01 E	01392 0	
	125 A	45 kW / 750 A	KG125 T104/01 E	00188 0	KG125 T204/01 E	00230 6	
	160 A	55 kW / 850 A	KG160 T104/01 E	00189 7	KG160 T204/01 E	00231 3	
IP 66 <sup>1</sup> 48 x 48  	16 A	7,5 kW / 160 A	KH16 T104/04 E	07097 8	KH16 T204/04 E	07098 5	
	20 A	10 kW / 200 A	KH20 T104/04 E	07099 2	KH20 T204/04 E	07100 5	
	25 A	12 kW / 250 A	KH25 T104/04 E	07101 2	KH25 T204/04 E	07102 9	
	32 A	11 kW / 220 A	KG32A T104/04 E	01236 7	KG32A T204/04 E	01248 0	
	40 A	15 kW / 300 A	KG41 T104/04 E	01238 1	KG41 T204/04 E	01250 3	
	63 A	22 kW / 350 A	KG64 T104/04 E	01240 4	KG64 T204/04 E	01252 7	
64 x 64  	16 A	7,5 kW / 160 A	KH16B T104/04 E	07103 6	KH16B T204/04 E	07106 7	
	20 A	10 kW / 200 A	KH20B T104/04 E	07104 3	KH20B T204/04 E	07107 4	
	25 A	12 kW / 250 A	KH25B T104/04 E	07105 0	KH25B T204/04 E	07108 1	
	32 A	16 kW / 300 A	KH32 T104/04 E	06514 1	KH32 T204/04 E	06515 8	
	40 A	20 kW / 380 A	KH40 T104/04 E	06516 5	KH40 T204/04 E	06517 2	
	63 A	30 kW / 500 A	KH63 T104/04 E	07495 2	KH63 T204/04 E	07488 4	
	80 A	40 kW / 630 A	KH80 T104/04 E	07496 9	KH80 T204/04 E	07489 1	
	100 A	37 kW / 650 A	KG100 T104/04 E	01243 5	KG100 T204/04 E	01255 8	
	88 x 88	80 A	30 kW / 560 A	KG80C T104/04 E	00201 6	KG80C T204/04 E	00243 6
		100 A	37 kW / 650 A	KG100C T104/04 E	00202 3	KG100C T204/04 E	00244 3
125 A		45 kW / 750 A	KG125 T104/04 E	00204 7	KG125 T204/04 E	00246 7	
160 A		55 kW / 850 A	KG160 T104/04 E	00205 4	KG160 T204/04 E	00247 4	
200 A		75 kW / 1100 A	KG210 T104/05 E	07497 6	KG210 T204/05 E	07490 7	
250 A		90 kW / 1380 A	KG250 T104/05 E	00207 8	KG250 T204/05 E	00249 8	
130 x 130	315 A	110 kW / 1650 A	KG315 T104/05 E	00208 5	KG315 T204/05 E	00250 4	
	315 A	132 kW / 2000 A	C316 T104/05 E	00209 2	C316 T204/05 E	00251 1	



[< back to table of contents >](#)

<sup>1</sup>C316 protection IP 40. Higher protection available on request.

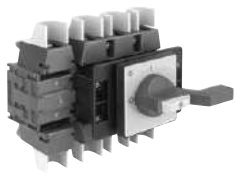
## Main Switches and Main Switches with Emergency Function 4 pole, for Four Hole Panel Mounting



Version	Thermal Current $I_u/I_{th}$	Ratings AC-23A, AC-23B Breaking Capacity 3 x 380 V/440 V	Main Switches	EAN-Code 9004257	Main Switches with Emergency Function	EAN-Code 9004257
Protection Escutcheon plate in mm			Handle black		Handle red Contrasting yellow plate	
IP 66 88 x 88 	250 A 315 A	90 kW / 1380 A 110 kW / 1650 A	KG250 T104/66 E KG315 T104/66 E	01256 5 01257 2	KG250 T204/66 E KG315 T204/66 E	01258 9 01259 6

## Main Switches and Main Switches with Emergency Function 4 pole, for Single Hole Mounting 22 mm

Version	Thermal Current $I_u/I_{th}$	Ratings AC-23A, AC-23B Breaking Capacity 3 x 380 V/440 V	Main Switches	EAN-Code 9004257	Main Switches with Emergency Function	EAN-Code 9004257
Protection Escutcheon plate in mm			Handle black		Handle red Contrasting yellow plate	
IP 66 64 x 64 	16 A 20 A 25 A 32 A 40 A 63 A 80 A	7,5 kW / 160 A 10 kW / 200 A 12 kW / 250 A 16 kW / 300 A 20 kW / 380 A 30 kW / 500 A 40 kW / 630 A	KH16 T104/01 FH3 KH20 T104/01 FH3 KH25 T104/01 FH3 KH32 T104/01 FH3 KH40 T104/01 FH3 KH63 T104/01 FH3 <sup>1</sup> KH80 T104/01 FH3 <sup>1</sup>	07109 8 07110 4 07111 1 06668 1 06669 8 08908 6 08910 9	KH16 T204/01 FH3 KH20 T204/01 FH3 KH25 T204/01 FH3 KH32 T204/01 FH3 KH40 T204/01 FH3 KH63 T204/01 FH3 <sup>1</sup> KH80 T204/01 FH3 <sup>1</sup>	07112 8 07113 5 07114 2 06670 4 06671 1 08909 3 08911 6
IP 66 48 x 48 	16 A 20 A 25 A 32 A	7,5 kW / 160 A 10 kW / 200 A 12 kW / 250 A 11 kW / 220 A	KH16 T104/04 FT2 KH20 T104/04 FT2 KH25 T104/04 FT2 KG32A T104/04 FT2	07115 9 07116 6 07117 3 01266 4	KH16 T204/04 FT2 KH20 T204/04 FT2 KH25 T204/04 FT2 KG32A T204/04 FT2	07118 0 07119 7 07120 3 01272 5
64 x 64	16 A 20 A 25 A 32 A 40 A 63 A 80 A	7,5 kW / 160 A 10 kW / 200 A 12 kW / 250 A 16 kW / 300 A 20 kW / 380 A 30 kW / 500 A 40 kW / 630 A	KH16 T104/04 FH3 KH20 T104/04 FH3 KH25 T104/04 FH3 KH32 T104/04 FH3 KH40 T104/04 FH3 KH63 T104/04 FH3 <sup>1</sup> KH80 T104/04 FH3 <sup>1</sup>	07121 0 07122 7 07123 4 06672 8 06673 5 08912 3 08914 7	KH16 T204/04 FH3 KH20 T204/04 FH3 KH25 T204/04 FH3 KH32 T204/04 FH3 KH40 T204/04 FH3 KH63 T204/04 FH3 <sup>1</sup> KH80 T204/04 FH3 <sup>1</sup>	07124 1 07125 8 07126 5 06674 2 06675 9 08913 0 08915 4

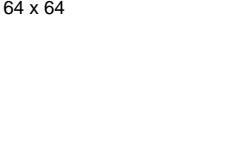

<sup>1</sup>For KH63 and KH80 use flexible wire only in order to avoid excessive pressure on single hole mounting.

**Main Switches and Main Switches with Emergency Function**  
**4 pole, for Base Mounting**  
**with Door Clutch, Padlock Device and Single Hole Mounting 22 mm**



Version	Thermal Current $I_U/I_{th}$	Ratings AC-23A, AC-23B Breaking Capacity 3 x 380 V/440 V	Main Switches Handle black	EAN-Code 9004257	Main Switches with Emergency Function Handle red Contrasting yellow plate	EAN-Code 9004257
IP 66 48 x 48 	16 A 20 A 25 A 32 A 40 A 63 A	7,5 kW / 160 A 10 kW / 200 A 12 kW / 250 A 11 kW / 220 A 15 kW / 300 A 22 kW / 350 A	KH16 T104/68 VE KH20 T104/68 VE KH25 T104/68 VE KG32A T104/68 VE KG41 T104/68 VE KG64 T104/68 VE	07127 2 07128 9 07129 6 01182 7 01184 1 01186 5	KH16 T204/68 VE KH20 T204/68 VE KH25 T204/68 VE KG32A T204/68 VE KG41 T204/68 VE KG64 T204/68 VE	07130 2 07131 9 07132 6 01194 0 01196 4 01198 8
64 x 64 	16 A 20 A 25 A 32 A 40 A 63 A 80 A 100 A	7,5 kW / 160 A 10 kW / 200 A 12 kW / 250 A 16 kW / 300 A 20 kW / 380 A 30 kW / 500 A 40 kW / 630 A 37 kW / 650 A	KH16B T104/68 VE KH20B T104/68 VE KH25B T104/68 VE KH32 T104/68 VE KH40 T104/68 VE KH63 T104/68 VE KH80 T104/68 VE KG100 T104/68 VE	07133 3 07134 0 07135 7 06518 9 06520 2 07498 3 07500 3 01189 6	KH16B T204/68 VE KH20B T204/68 VE KH25B T204/68 VE KH32 T204/68 VE KH40 T204/68 VE KH63 T204/68 VE KH80 T204/68 VE KG100 T204/68 VE	07136 4 07137 1 07138 8 06519 6 06521 9 07499 0 07501 0 01201 5
IP 66 64 x 64  <p>Misalignment between the shaft and operator is compensated for by a centering device.</p>	16 A 20 A 25 A 32 A 40 A 63 A 80 A 100 A	7,5 kW / 160 A 10 kW / 200 A 12 kW / 250 A 16 kW / 300 A 20 kW / 380 A 30 kW / 500 A 40 kW / 630 A 37 kW / 650 A	KH16B T104/93 VE KH20B T104/93 VE KH25B T104/93 VE KH32 T104/93 VE KH40 T104/93 VE KH63 T104/93 VE KH80 T104/93 VE KG100 T104/93 VE	07139 5 07140 1 07141 8 06522 6 06524 0 07502 7 07504 1 06381 9	KH16B T204/93 VE KH20B T204/93 VE KH25B T204/93 VE KH32 T204/93 VE KH40 T204/93 VE KH63 T204/93 VE KH80 T204/93 VE KG100 T204/93 VE	07142 5 07143 2 07144 9 06523 3 06525 7 07503 4 07505 8 06388 8
IP 66 64 x 64  <p>Misalignment between the shaft and operator is compensated for by a centering device.</p>	16 A 20 A 25 A 32 A 40 A 63 A 80 A 100 A	7,5 kW / 160 A 10 kW / 200 A 12 kW / 250 A 16 kW / 300 A 20 kW / 380 A 30 kW / 500 A 40 kW / 630 A 37 kW / 650 A	KH16B T104/94 VE KH20B T104/94 VE KH25B T104/94 VE KH32 T104/94 VE KH40 T104/94 VE KH63 T104/94 VE KH80 T104/94 VE KG100 T104/94 VE	07145 6 07146 3 07147 0 06526 4 06528 8 07506 5 07508 9 06395 6	KH16B T204/94 VE KH20B T204/94 VE KH25B T204/94 VE KH32 T204/94 VE KH40 T204/94 VE KH63 T204/94 VE KH80 T204/94 VE KG100 T204/94 VE	07148 7 07149 4 07150 0 06527 1 06529 5 07507 2 07509 6 06402 1

[< back to table of contents >](#)

## Main Switches and Main Switches with Emergency Function 4 pole, for Base Mounting with Door Clutch

Version	Thermal Current $I_{U/I_{th}}$	Ratings AC-23A, AC-23B Breaking Capacity 3 x 380 V/440 V	Main Switches		EAN-Code 9004257	Main Switches with Emergency Function		EAN-Code 9004257	
Protection Escutcheon plate in mm			Handle black			Handle red Contrasting yellow plate			
IP 66/67 64 x 64  	16 A	7,5 kW / 160 A	KH16B	T104/09 VE	07151 7	KH16B	T204/09 VE	07154 8	
	20 A	10 kW / 200 A	KH20B	T104/09 VE	07152 4	KH20B	T204/09 VE	07155 5	
	25 A	12 kW / 250 A	KH25B	T104/09 VE	07153 1	KH25B	T204/09 VE	07156 2	
	32 A	16 kW / 300 A	KH32	T104/09 VE	06530 1	KH32	T204/09 VE	06531 8	
	40 A	20 kW / 380 A	KH40	T104/09 VE	06532 5	KH40	T204/09 VE	06533 2	
	63 A	30 kW / 500 A	KH63	T104/09 VE	07510 2	KH63	T204/09 VE	07511 9	
	80 A	40 kW / 630 A	KH80	T104/09 VE	07512 6	KH80	T204/09 VE	07513 3	
	100 A	37 kW / 650 A	KG100	T104/09 VE	00278 8	KG100	T204/09 VE	00292 4	
	88 x 88	125 A	45 kW / 750 A	KG125	T104/09 VE	00280 1	KG125	T204/09 VE	00294 8
		160 A	55 kW / 850 A	KG160	T104/09 VE	00281 8	KG160	T204/09 VE	00295 5
IP 66/67 48 x 48  64 x 64  	16 A	7,5 kW / 160 A	KH16	T104/65 VE	07157 9	KH16	T204/65 VE	07160 9	
	20 A	10 kW / 200 A	KH20	T104/65 VE	07158 6	KH20	T204/65 VE	07161 6	
	25 A	12 kW / 250 A	KH25	T104/65 VE	07159 3	KH25	T204/65 VE	07162 3	
	64 x 64	16 A	7,5 kW / 160 A	KH16B	T104/65 VE	07163 0	KH16B	T204/65 VE	07166 1
		20 A	10 kW / 200 A	KH20B	T104/65 VE	07164 7	KH20B	T204/65 VE	07167 8
		25 A	12 kW / 250 A	KH25B	T104/65 VE	07165 4	KH25B	T204/65 VE	07168 5
		32 A	16 kW / 300 A	KH32	T104/65 VE	06534 9	KH32	T204/65 VE	06535 6
		40 A	20 kW / 380 A	KH40	T104/65 VE	06536 3	KH40	T204/65 VE	06537 0
		63 A	30 kW / 500 A	KH63	T104/65 VE	07514 0	KH63	T204/65 VE	07515 7
		80 A	40 kW / 630 A	KH80	T104/65 VE	07516 4	KH80	T204/65 VE	07517 1
100 A	37 kW / 650 A	KG100	T104/65 VE	01165 0	KG100	T204/65 VE	01177 3		
88 x 88	125 A	45 kW / 750 A	KG125	T104/65 VE	03174 0	KG125	T204/65 VE	03178 8	
	160 A	55 kW / 850 A	KG160	T104/65 VE	03175 7	KG160	T204/65 VE	03179 5	
	250 A	90 kW / 1380 A	KG250	T104/83 VE	03198 6	KG250	T204/83 VE	03200 6	
	315 A	110 kW / 1650 A	KG315	T104/83 VE	03199 3	KG315	T204/83 VE	03201 3	
IP 66 88 x 88   <p>Using the device the electrical panel may be opened only when the switch is in the OFF position and no padlock is fitted. Note: Only in the ON position can knowledgeable personnel using a simple tool to defeat the interlock. The M700's flexibility allows for successful installation with as much as + or - 5 mm of misalignment between the shaft and door.</p>	25 A	7,5 kW / 180 A	KG20B	T104/12 VE	00307 5	KG20B	T204/12 VE	00337 2	
	32 A	16 kW / 300 A	KH32	T104/12 VE	06538 7	KH32	T204/12 VE	06539 4	
	40 A	20 kW / 380 A	KH40	T104/12 VE	06540 0	KH40	T204/12 VE	06541 7	
	63 A	30 kW / 500 A	KH63	T104/12 VE	07518 8	KH63	T204/12 VE	07519 5	
	80 A	40 kW / 630 A	KH80	T104/12 VE	07520 1	KH80	T204/12 VE	07521 8	
	100 A	37 kW / 650 A	KG100	T104/12 VE	00312 9	KG100	T204/12 VE	00342 6	
	125 A	45 kW / 750 A	KG125	T104/12 VE	00314 3	KG125	T204/12 VE	00344 0	
	160 A	55 kW / 850 A	KG160	T104/12 VE	00315 0	KG160	T204/12 VE	00345 7	
	200 A	75 kW / 1100 A	KG210	T104/13 VE	07522 5	KG210	T204/13 VE	07523 2	
	250 A	90 kW / 1380 A	KG250	T104/13 VE	00317 4	KG250	T204/13 VE	00347 1	
	315 A	110 kW / 1650 A	KG315	T104/13 VE	00318 1	KG315	T204/13 VE	00348 8	
	315 A	132 kW / 2000 A	C316	T104/13 VE	00319 8	C316	T204/13 VE	00349 5	

## Main Switches and Main Switches with Emergency Function 3 pole + Ground and Neutral Terminal, for Four Hole Panel Mounting

Version	Thermal Current $I_U/I_{th}$	Ratings AC-23A, AC-23B Breaking Capacity 3 x 380 V/440 V	Main Switches Handle black	EAN-Code 9004257	Main Switches with Emergency Function Handle red Contrasting yellow plate	EAN-Code 9004257
IP 66 64 x 64  	25 A	7,5 kW / 180 A	KG20B T105/01 E	01396 8	KG20B T205/01 E	01407 1
	32 A	11 kW / 220 A	KG32B T105/01 E	01397 5	KG32B T205/01 E	01408 8
	40 A	15 kW / 300 A	KG41B T105/01 E	01398 2	KG41B T205/01 E	01409 5
	63 A	22 kW / 350 A	KG64B T105/01 E	01399 9	KG64B T205/01 E	01410 1
	80 A	30 kW / 560 A	KG80 T105/01 E	01400 2	KG80 T205/01 E	01411 8
	100 A	37 kW / 650 A	KG100 T105/01 E	01402 6	KG100 T205/01 E	01413 2
88 x 88	80 A	30 kW / 560 A	KG80C T105/01 E	01401 9	KG80C T205/01 E	01412 5
	100 A	37 kW / 650 A	KG100C T105/01 E	01403 3	KG100C T205/01 E	01414 9
	125 A	45 kW / 750 A	KG125 T105/01 E	01404 0	KG125 T205/01 E	01415 6
	160 A	55 kW / 850 A	KG160 T105/01 E	01405 7	KG160 T205/01 E	01416 3
IP 66 <sup>1</sup> 48 x 48  	25 A	7,5 kW / 180 A	KG20A T105/04 E	01418 7	KG20A T205/04 E	01434 7
	32 A	11 kW / 220 A	KG32A T105/04 E	01419 4	KG32A T205/04 E	01435 4
	40 A	15 kW / 300 A	KG41 T105/04 E	01420 0	KG41 T205/04 E	01436 1
	63 A	22 kW / 350 A	KG64 T105/04 E	01421 7	KG64 T205/04 E	01437 8
64 x 64	25 A	7,5 kW / 180 A	KG20B T105/04 E	01423 1	KG20B T205/04 E	01439 2
	32 A	11 kW / 220 A	KG32B T105/04 E	01424 8	KG32B T205/04 E	01440 8
	40 A	15 kW / 300 A	KG41B T105/04 E	01425 5	KG41B T205/04 E	01441 5
	63 A	22 kW / 350 A	KG64B T105/04 E	01426 2	KG64B T205/04 E	01442 2
	80 A	30 kW / 560 A	KG80 T105/04 E	01427 9	KG80 T205/04 E	01443 9
	100 A	37 kW / 650 A	KG100 T105/04 E	01428 6	KG100 T205/04 E	01444 6
88 x 88	80 A	30 kW / 560 A	KG80C T105/04 E	01429 3	KG80C T205/04 E	01445 3
	100 A	37 kW / 650 A	KG100C T105/04 E	01430 9	KG100C T205/04 E	01446 0
	125 A	45 kW / 750 A	KG125 T105/04 E	01431 6	KG125 T205/04 E	01447 7
	160 A	55 kW / 850 A	KG160 T105/04 E	01432 3	KG160 T205/04 E	01448 4
	200 A	75 kW / 1100 A	KG210 T105/05 E	07524 9	KG210 T205/05 E	07525 6
	250 A	90 kW / 1380 A	KG250 T105/05 E	01449 1	KG250 T205/05 E	01451 4
	315 A	110 kW / 1650 A	KG315 T105/05 E	01450 7	KG315 T205/05 E	01452 1

[< back to table of contents >](#)



<sup>1</sup>C316 protection IP 40. Higher protection available on request.



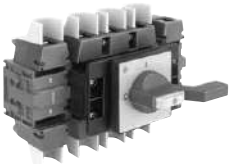

## Main Switches and Main Switches with Emergency Function 3 pole + Ground and Neutral Terminal, for Four Hole Panel Mounting

Version	Thermal Current $I_u/I_{th}$	Ratings AC-23A, AC-23B Breaking Capacity 3 x 380 V/440 V	Main Switches Handle black	EAN-Code 9004257	Main Switches with Emergency Function Handle red Contrasting yellow plate	EAN-Code 9004257
IP 66 88 x 88  	250 A 315 A	90 kW / 1380 A 110 kW/1650 A	KG250 T105/66 E KG315 T105/66 E	01584 9 01585 6	KG250 T205/66 E KG315 T205/66 E	01586 3 01587 0

## Main Switches and Main Switches with Emergency Function 3 pole + Ground and Neutral Terminal, for Single Hole Mounting 22 mm





Version	Thermal Current $I_u/I_{th}$	Ratings AC-23A, AC-23B Breaking Capacity 3 x 380 V/440 V	Main Switches Handle black	EAN-Code 9004257	Main Switches with Emergency Function Handle red Contrasting yellow plate	EAN-Code 9004257
IP 66 64 x 64  	25 A 32 A	7,5 kW / 180 A 11 kW / 220 A	KG20B T105/01 FT2 KG32B T105/01 FT2	01454 5 01455 2	KG20B T205/01 FT2 KG32B T205/01 FT2	01457 6 01458 3
IP 66 48 x 48  	25 A 32 A	7,5 kW / 180 A 11 kW / 220 A	KG20A T105/04 FT2 KG32A T105/04 FT2	01460 6 01461 3	KG20A T205/04 FT2 KG32A T205/04 FT2	01463 7 01464 4
64 x 64  	25 A 32 A	7,5 kW / 180 A 11 kW / 220 A	KG20B T105/04 FT2 KG32B T105/04 FT2	01601 3 01603 7	KG20B T205/04 FT2 KG32B T205/04 FT2	01602 0 01604 4

**Main Switches and Main Switches with Emergency Function**  
**3 pole + Ground and Neutral Terminal, for Base Mounting**  
**with Door Clutch, Padlock Device and Single Hole Mounting 22 mm**

Version	Thermal Current $I_U/I_{th}$	Ratings AC-23A, AC-23B Breaking Capacity 3 x 380 V/440 V	Main Switches Handle black	EAN-Code 9004257	Main Switches with Emergency Function Handle red Contrasting yellow plate	EAN-Code 9004257
IP 66 48 x 48 	25 A 32 A 40 A 63 A	7,5 kW / 180 A 11 kW / 220 A 15 kW / 300 A 22 kW / 350 A	KG20A T105/68 VE KG32A T105/68 VE KG41 T105/68 VE KG64 T105/68 VE	01524 5 01525 2 01526 9 01527 6	KG20A T205/68 VE KG32A T205/68 VE KG41 T205/68 VE KG64 T205/68 VE	01529 0 01530 6 01531 3 01532 0
64 x 64	25 A 32 A 40 A 63 A 80 A 100 A	7,5 kW / 180 A 11 kW / 220 A 15 kW / 300 A 22 kW / 350 A 30 kW / 560 A 37 kW / 650 A	KG20B T105/68 VE KG32B T105/68 VE KG41B T105/68 VE KG64B T105/68 VE KG80 T105/68 VE KG100 T105/68 VE	01607 5 01609 9 01611 2 01613 6 01615 0 01617 4	KG20B T205/68 VE KG32B T205/68 VE KG41B T205/68 VE KG64B T205/68 VE KG80 T205/68 VE KG100 T205/68 VE	01608 2 01610 5 01612 9 01614 3 01616 7 01618 1
IP 66 64 x 64   Misalignment between the shaft and operator is compensated for by a centering device.	25 A 32 A 40 A 63 A 80 A 100 A	7,5 kW / 180 A 11 kW / 220 A 15 kW / 300 A 22 kW / 350 A 30 kW / 560 A 37 kW / 650 A	KG20B T105/93 VE KG32B T105/93 VE KG41B T105/93 VE KG64B T105/93 VE KG80 T105/93 VE KG100 T105/93 VE	06403 8 06404 5 06405 2 06406 9 06407 6 06408 3	KG20B T205/93 VE KG32B T205/93 VE KG41B T205/93 VE KG64B T205/93 VE KG80 T205/93 VE KG100 T205/93 VE	06409 0 06410 6 06411 3 06412 0 06413 7 06414 4
IP 66 64 x 64   Misalignment between the shaft and operator is compensated for by a centering device.	25 A 32 A 40 A 63 A 80 A 100 A	7,5 kW / 180 A 11 kW / 220 A 15 kW / 300 A 22 kW / 350 A 30 kW / 560 A 37 kW / 650 A	KG20B T105/94 VE KG32B T105/94 VE KG41B T105/94 VE KG64B T105/94 VE KG80 T105/94 VE KG100 T105/94 VE	06415 1 06416 8 06417 5 06418 2 06419 9 06420 5	KG20B T205/94 VE KG32B T205/94 VE KG41B T205/94 VE KG64B T205/94 VE KG80 T205/94 VE KG100 T205/94 VE	06421 2 06422 9 06423 6 06424 3 06425 0 06426 7

< back to table of contents >



## Main Switches and Main Switches with Emergency Function 3 pole + Ground and Neutral Terminal, for Base Mounting with Door Clutch

Version	Thermal Current $I_{U}/I_{th}$	Ratings AC-23A, AC-23B Breaking Capacity 3 x 380 V/440 V	Main Switches	EAN-Code 9004257	Main Switches with Emergency Function	EAN-Code 9004257
Protection Escutcheon plate in mm  IP 66/67 64 x 64  	25 A 32 A 40 A 63 A 80 A 100 A	7,5 kW / 180 A 11 kW / 220 A 15 kW / 300 A 22 kW / 350 A 30 kW / 560 A 37 kW / 650 A	Handle black  KG20B T105/09 VE KG32B T105/09 VE KG41B T105/09 VE KG64B T105/09 VE KG80 T105/09 VE KG100 T105/09 VE	01466 8 01467 5 01468 2 01469 9 01470 5 01471 2	Handle red Contrasting yellow plate  KG20B T205/09 VE KG32B T205/09 VE KG41B T205/09 VE KG64B T205/09 VE KG80 T205/09 VE KG100 T205/09 VE	01475 0 01476 7 01477 4 01478 1 01479 8 01480 4
88 x 88  IP 66/67 48 x 48  	125 A 160 A	45 kW / 750 A 55 kW / 850 A	KG125 T105/09 VE KG160 T105/09 VE	01472 9 01473 6	KG125 T205/09 VE KG160 T205/09 VE	01481 1 01482 8
64 x 64  IP 66/67 48 x 48  	25 A 32 A 40 A 63 A 80 A 100 A	7,5 kW / 180 A 11 kW / 220 A 15 kW / 300 A 22 kW / 350 A 30 kW / 560 A 37 kW / 650 A	KG20A T105/65 VE KG32A T105/65 VE  KG20B T105/65 VE KG32B T105/65 VE KG41B T105/65 VE KG64B T105/65 VE KG80 T105/65 VE KG100 T105/65 VE	01485 9 01487 3  01486 6 01488 0 01410 3 01492 7 01493 4 01494 1	KG20A T205/65 VE KG32A T205/65 VE  KG20B T205/65 VE KG32B T205/65 VE KG41B T205/65 VE KG64B T205/65 VE KG80 T205/65 VE KG100 T205/65 VE	01497 2 01499 6  01498 9 01500 9 01502 3 01504 7 01505 4 01506 1
IP 66 88 x 88   <p>Using the device the electrical panel may be opened only when the switch is in the OFF position and no padlock is fitted. Note: Only in the ON position can knowledgeable personnel using a simple tool to defeat the interlock. The M700's flexibility allows for successful installation with as much as + or - 5 mm of misalignment between the shaft and door.</p>	25 A 32 A 40 A 63 A 80 A 100 A 125 A 160 A 200 A 250 A 315 A	7,5 kW / 180 A 11 kW / 220 A 15 kW / 300 A 22 kW / 350 A 30 kW / 560 A 37 kW / 650 A 45 kW / 750 A 55 kW / 850 A 75 kW / 1100 A 90 kW / 1380 A 110 kW / 1650 A	KG20B T105/12 VE KG32B T105/12 VE KG41B T105/12 VE KG64B T105/12 VE KG80 T105/12 VE KG100 T105/12 VE KG125 T105/12 VE KG160 T105/12 VE KG210 T105/13 VE KG250 T105/13 VE KG315 T105/13 VE	01619 8 01621 1 01507 8 01508 5 01509 2 01510 8 01511 5 01512 2 07526 3 01513 9 01514 6	KG20B T205/12 VE KG32B T205/12 VE KG41B T205/12 VE KG64B T205/12 VE KG80 T205/12 VE KG100 T205/12 VE KG125 T205/12 VE KG160 T205/12 VE KG210 T205/13 VE KG250 T205/13 VE KG315 T205/13 VE	01620 4 01622 8 01515 3 01516 0 01517 7 01518 4 01519 1 01520 7 07527 0 01521 4 01522 1

< back to table of contents >

## Main Switches and Main Switches with Emergency Function 3 pole + 1 cam- or rack-operated auxiliary contact (NO), for Four Hole Panel Mounting

Auxiliary contacts with special contact systems allow for use in low voltage and current applications as well as aggressive environments.

Version	Thermal Current $I_U/I_{th}$	Ratings AC-23A, AC-23B Breaking Capacity 3 x 380 V/440 V	Main Switches Handle black	EAN-Code 9004257	Main Switches with Emergency Function Handle red Contrasting yellow plate	EAN-Code 9004257	
IP 66 64 x 64  	20 A	5,5 kW / 120 A	KG10B T103/17 E	01045 5	KG10B T203/17 E	01050 9	
	25 A	7,5 kW / 180 A	KG20B T103/17 E	00361 7	KG20B T203/17 E	00401 0	
	32 A	11 kW / 220 A	KG32B T103/17 E	00362 4	KG32B T203/17 E	00402 7	
	40 A	15 kW / 300 A	KG41B T103/17 E	00363 1	KG41B T203/17 E	00403 4	
	63 A	22 kW / 350 A	KG64B T103/17 E	00364 8	KG64B T203/17 E	00404 1	
	80 A	30 kW / 560 A	KG80 T103/17 E	00365 5	KG80 T203/17 E	00405 8	
	100 A	37 kW / 650 A	KG100 T103/17 E	00366 2	KG100 T203/17 E	00406 5	
88 x 88	80 A	30 kW / 560 A	KG80C T103/17 E	01387 6	KG80C T203/17 E	01393 7	
	100 A	37 kW / 650 A	KG100C T103/17 E	01388 3	KG100C T203/17 E	01394 4	
	125 A	45 kW / 750 A	KG125 T103/17 E	00368 6	KG125 T203/17 E	00408 9	
	160 A	55 kW / 850 A	KG160 T103/17 E	00369 3	KG160 T203/17 E	00409 6	
IP 66 <sup>1</sup> 48 x 48	20 A	5,5 kW / 120 A	KG10A T103/20 E	01202 2	KG10A T203/20 E	01214 5	
	25 A	7,5 kW / 180 A	KG20A T103/20 E	01204 6	KG20A T203/20 E	01216 9	
	32 A	11 kW / 220 A	KG32A T103/20 E	01206 0	KG32A T203/20 E	01218 3	
64 x 64  	20 A	5,5 kW / 120 A	KG10B T103/20 E	01203 9	KG10B T203/20 E	01215 2	
	25 A	7,5 kW / 180 A	KG20B T103/20 E	01205 3	KG20B T203/20 E	01217 6	
	32 A	11 kW / 220 A	KG32B T103/20 E	01207 7	KG32B T203/20 E	01219 0	
	40 A	15 kW / 300 A	KG41B T103/20 E	01209 1	KG41B T203/20 E	01221 3	
	63 A	22 kW / 350 A	KG64B T103/20 E	01211 4	KG64B T203/20 E	01223 7	
	80 A	30 kW / 560 A	KG80 T103/20 E	01212 1	KG80 T203/20 E	01224 4	
	100 A	37 kW / 650 A	KG100 T103/20 E	01213 8	KG100 T203/20 E	01225 1	
	88 x 88	80 A	30 kW / 560 A	KG80C T103/20 E	00379 2	KG80C T203/20 E	00419 5
		100 A	37 kW / 650 A	KG100C T103/20 E	00380 8	KG100C T203/20 E	00420 1
125 A		45 kW / 750 A	KG125 T103/20 E	00382 2	KG125 T203/20 E	00422 5	
160 A		55 kW / 850 A	KG160 T103/20 E	00383 9	KG160 T203/20 E	00423 2	
200 A		75 kW / 1100 A	KG210 T103/21 E	07528 7	KG210 T203/21 E	07529 4	
250 A		90 kW / 1380 A	KG250 T103/21 E	00385 3	KG250 T203/21 E	00425 6	
315 A	110 kW / 1650 A	KG315 T103/21 E	00386 0	KG315 T203/21 E	00426 3		
130 x 130	315 A	132 kW / 2000 A	C316 T103/21 E	00387 7	C316 T203/21 E	00427 0	

[< back to table of contents >](#)

<sup>1</sup>C316 protection IP 40. Higher protection available on request.

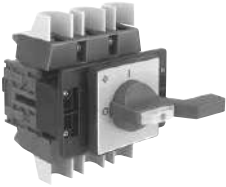

## Main Switches and Main Switches with Emergency Function 3 pole + 1 cam- or rack-operated auxiliary contact (NO), for Four Hole Panel Mounting

Auxiliary contacts with special contact systems allow for use in low voltage and current applications as well aggressive environments.

Version	Thermal Current $I_u/I_{th}$	Ratings AC-23A, AC-23B Breaking Capacity 3 x 380 V/440 V	Main Switches	EAN-Code 9004257	Main Switches with Emergency Function	EAN-Code 9004257
Protection Escutcheon plate in mm			Handle black		Handle red Contrasting yellow plate	
IP 66 88 x 88	250 A 315 A	90 kW / 1380 A 110 kW / 1650 A	KG250 T103/70 E KG315 T103/70 E	01226 8 01227 5	KG250 T203/70 E KG315 T203/70 E	01228 2 01229 9
						



## Main Switches and Main Switches with Emergency Function 3 pole + 1 cam-operated auxiliary contact (NO), for Single Hole Mounting 22 mm

Auxiliary contacts with special contact systems allow for use in low voltage and current applications as well aggressive environments.

Version	Thermal Current $I_u/I_{th}$	Ratings AC-23A, AC-23B Breaking Capacity 3 x 380 V/440 V	Main Switches	EAN-Code 9004257	Main Switches with Emergency Function	EAN-Code 9004257
Protection Escutcheon plate in mm			Handle black		Handle red Contrasting yellow plate	
IP 66 64 x 64	20 A 25 A 32 A	5,5 kW / 120 A 7,5 kW / 180 A 11 kW / 220 A	KG10B T103/17 FT2 KG20B T103/17 FT2 KG32B T103/17 FT2	01302 9 00441 6 00442 3	KG10B T203/17 FT2 KG20B T203/17 FT2 KG32B T203/17 FT2	01303 6 00445 4 00446 1
						
IP 66 48 x 48	20 A 25 A 32 A	5,5 kW / 120 A 7,5 kW / 180 A 11 kW / 220 A	KG10A T103/20 FT2 KG20A T103/20 FT2 KG32A T103/20 FT2	01304 3 01306 7 01308 1	KG10A T203/20 FT2 KG20A T203/20 FT2 KG32A T203/20 FT2	01310 4 01312 8 01314 2
						
64 x 64	20 A 25 A 32 A	5,5 kW / 120 A 7,5 kW / 180 A 11 kW / 220 A	KG10B T103/20 FT2 KG20B T103/20 FT2 KG32B T103/20 FT2	01305 0 01307 4 01309 8	KG10B T203/20 FT2 KG20B T203/20 FT2 KG32B T203/20 FT2	01311 1 01313 5 01315 9

## Main Switches and Main Switches with Emergency Function 3 pole + 1 cam-operated auxiliary contact (NO), for Base Mounting with Door Clutch, Padlock Device and Single Hole Mounting 22 mm



Auxiliary contacts with special contact systems allow for use in low voltage and current applications as well aggressive environments.

Version	Thermal Current $I_U/I_{th}$	Ratings AC-23A, AC-23B Breaking Capacity 3 x 380 V/440 V	Main Switches Handle black	EAN-Code 9004257	Main Switches with Emergency Function Handle red Contrasting yellow plate	EAN-Code 9004257
IP 66 48 x 48 	20 A 25 A 32 A 40 A 63 A	5,5 kW / 120 A 7,5 kW / 180 A 11 kW / 220 A 15 kW / 300 A 22 kW / 350 A	KG10A T103/72 VE KG20A T103/72 VE KG32A T103/72 VE KG41 T103/72 VE KG64 T103/72 VE	01342 5 01344 9 01346 3 01348 7 01350 0	KG10A T203/72 VE KG20A T203/72 VE KG32A T203/72 VE KG41 T203/72 VE KG64 T203/72 VE	01354 8 01356 2 01358 6 01360 9 01362 3
64 x 64	20 A 25 A 32 A 40 A 63 A 80 A 100 A	5,5 kW / 120 A 7,5 kW / 180 A 11 kW / 220 A 15 kW / 300 A 22 kW / 350 A 30 kW / 560 A 37 kW / 650 A	KG10B T103/72 VE KG20B T103/72 VE KG32B T103/72 VE KG41B T103/72 VE KG64B T103/72 VE KG80 T103/72 VE KG100 T103/72 VE	01343 2 01345 6 01347 0 01349 4 01351 7 01352 4 01353 1	KG10B T203/72 VE KG20B T203/72 VE KG32B T203/72 VE KG41B T203/72 VE KG64B T203/72 VE KG80 T203/72 VE KG100 T203/72 VE	01355 5 01357 9 01359 3 01361 6 01363 0 01364 7 01365 4
IP 66 64 x 64   Misalignment between the shaft and operator is compensated for by a centering device.	20 A 25 A 32 A 40 A 63 A 80 A 100 A	5,5 kW / 120 A 7,5 kW / 180 A 11 kW / 220 A 15 kW / 300 A 22 kW / 350 A 30 kW / 560 A 37 kW / 650 A	KG10B T103/95 VE KG20B T103/95 VE KG32B T103/95 VE KG41B T103/95 VE KG64B T103/95 VE KG80 T103/95 VE KG100 T103/95 VE	06427 4 06428 1 06429 8 06430 4 06431 1 06432 8 06433 5	KG10B T203/95 VE KG20B T203/95 VE KG32B T203/95 VE KG41B T203/95 VE KG64B T203/95 VE KG80 T203/95 VE KG100 T203/95 VE	06434 2 06435 9 06436 6 06437 3 06438 0 06439 7 06440 3
IP 66 64 x 64   Misalignment between the shaft and operator is compensated for by a centering device.	20 A 25 A 32 A 40 A 63 A 80 A 100 A	5,5 kW / 120 A 7,5 kW / 180 A 11 kW / 220 A 15 kW / 300 A 22 kW / 350 A 30 kW / 560 A 37 kW / 650 A	KG10B T103/96 VE KG20B T103/96 VE KG32B T103/96 VE KG41B T103/96 VE KG64B T103/96 VE KG80 T103/96 VE KG100 T103/96 VE	06441 0 06442 7 06443 4 06444 1 06445 8 06446 5 06447 2	KG10B T203/96 VE KG20B T203/96 VE KG32B T203/96 VE KG41B T203/96 VE KG64B T203/96 VE KG80 T203/96 VE KG100 T203/96 VE	06448 9 06449 6 06450 2 06451 9 06452 6 06453 3 06454 0

< back to table of contents >

## Main Switches and Main Switches with Emergency Function 3 pole + 1 cam- or rack-operated auxiliary contact (NO), for Base Mounting with Door Clutch



Auxiliary contacts with special contact systems allow for use in low voltage and current applications as well aggressive environments.

Version	Thermal Current $I_u/I_{th}$	Ratings AC-23A, AC-23B Breaking Capacity 3 x 380 V/440 V	Main Switches	EAN-Code 9004257	Main Switches with Emergency Function	EAN-Code 9004257	
Protection Escutcheon plate in mm			Handle black		Handle red Contrasting yellow plate		
IP 66/67 64 x 64  	20 A	5,5 kW / 120 A	KG10B T103/25 VE	01316 6	KG10B T203/25 VE	01317 3	
	25 A	7,5 kW / 180 A	KG20B T103/25 VE	00449 2	KG20B T203/25 VE	00463 8	
	32 A	11 kW / 220 A	KG32B T103/25 VE	00450 8	KG32B T203/25 VE	00464 5	
	40 A	15 kW / 300 A	KG41B T103/25 VE	00451 5	KG41B T203/25 VE	00465 2	
	63 A	22 kW / 350 A	KG64B T103/25 VE	00452 2	KG64B T203/25 VE	00466 9	
	80 A	30 kW / 560 A	KG80 T103/25 VE	00453 9	KG80 T203/25 VE	00467 6	
	100 A	37 kW / 650 A	KG100 T103/25 VE	00454 6	KG100 T203/25 VE	00468 3	
	88 x 88	125 A	45 kW / 750 A	KG125 T103/25 VE	00456 0	KG125 T203/25 VE	00470 6
	160 A	55 kW / 850 A	KG160 T103/25 VE	00457 7	KG160 T203/25 VE	00471 3	
	IP 66/67 48 x 48  	20 A	5,5 kW / 120 A	KG10A T103/69 VE	01318 0	KG10A T203/69 VE	01330 2
25 A		7,5 kW / 180 A	KG20A T103/69 VE	01320 3	KG20A T203/69 VE	01332 6	
32 A		11 kW / 220 A	KG32A T103/69 VE	01322 7	KG32A T203/69 VE	01334 0	
64 x 64		20 A	5,5 kW / 120 A	KG10B T103/69 VE	01319 7	KG10B T203/69 VE	01331 9
25 A		7,5 kW / 180 A	KG20B T103/69 VE	01321 0	KG20B T203/69 VE	01333 3	
32 A		11 kW / 220 A	KG32B T103/69 VE	01323 4	KG32B T203/69 VE	01335 7	
40 A		15 kW / 300 A	KG41B T103/69 VE	01325 8	KG41B T203/69 VE	01337 1	
63 A		22 kW / 350 A	KG64B T103/69 VE	01327 2	KG64B T203/69 VE	01339 5	
80 A		30 kW / 560 A	KG80 T103/69 VE	01328 9	KG80 T203/69 VE	01340 1	
100 A		37 kW / 650 A	KG100 T103/69 VE	01329 6	KG100 T203/69 VE	01341 8	
IP 66 88 x 88   <p>Using the device the electrical panel may be opened only when the switch is in the OFF position and no padlock is fitted. Note: Only in the ON position can knowledgeable personnel using a simple tool to defeat the interlock. The M700's flexibility allows for successful installation with as much as + or - 5 mm of misalignment between the shaft and door.</p>	25 A	7,5 kW / 180 A	KG20B T103/28 VE	01625 9	KG20B T203/28 VE	00513 0	
	32 A	11 kW / 220 A	KG32B T103/28 VE	00484 3	KG32B T203/28 VE	00514 7	
	40 A	15 kW / 300 A	KG41B T103/28 VE	00485 0	KG41B T203/28 VE	00515 4	
	63 A	22 kW / 350 A	KG64B T103/28 VE	00486 7	KG64B T203/28 VE	00516 1	
	80 A	30 kW / 560 A	KG80 T103/28 VE	00487 4	KG80 T203/28 VE	00517 8	
	100 A	37 kW / 650 A	KG100 T103/28 VE	00488 1	KG100 T203/28 VE	00518 5	
	125 A	45 kW / 750 A	KG125 T103/28 VE	00490 4	KG125 T203/28 VE	00520 8	
	160 A	55 kW / 850 A	KG160 T103/28 VE	00491 1	KG160 T203/28 VE	00521 5	
	200 A	75 kW / 1100 A	KG210 T103/29 VE	07530 0	KG210 T203/29 VE	07531 7	
	250 A	90 kW / 1380 A	KG250 T103/29 VE	00493 5	KG250 T203/29 VE	00523 9	
	315 A	110 kW / 1650 A	KG315 T103/29 VE	00494 2	KG315 T203/29 VE	00524 6	
	315 A	132 kW / 2000 A	C316 T103/29 VE	00495 9	C316 T203/29 VE	00525 3	

< back to table of contents >

## Main Switches and Main Switches with Emergency Function 3 pole + 2 cam- or rack-operated auxiliary contacts (1 NO,1 NC), for Four Hole Panel Mounting

Auxiliary contacts with special contact systems allow for use in low voltage and current applications as well aggressive environments.

Version	Thermal Current $I_U/I_{th}$	Ratings AC-23A, AC-23B Breaking Capacity 3 x 380 V/440 V	Main Switches Handle black	EAN-Code 9004257	Main Switches with Emergency Function Handle red Contrasting yellow plate	EAN-Code 9004257
IP 66 64 x 64  	20 A	5,5 kW / 120 A	KG10B T103/A1 E	193325	KG10B T203/A1 E	193332
	25 A	7,5 kW / 180 A	KG20B T103/A1 E	192854	KG20B T203/A1 E	192861
	32 A	11 kW / 220 A	KG32B T103/A1 E	192878	KG32B T203/A1 E	192885
	40 A	15 kW / 300 A	KG41B T103/A1 E	193158	KG41B T203/A1 E	193172
	63 A	22 kW / 350 A	KG64B T103/A1 E	192892	KG64B T203/A1 E	192915
	80 A	30 kW / 560 A	KG80 T103/A1 E	191796	KG80 T203/A1 E	191819
	100 A	37 kW / 650 A	KG100 T103/A1 E	191833	KG100 T203/A1 E	191840
88 x 88	80 A	30 kW / 560 A	KG80C T103/A1 E	191635	KG80C T203/A1 E	191642
	100 A	37 kW / 650 A	KG100C T103/A1 E	191611	KG100C T203/A1 E	191628
	125 A	45 kW / 750 A	KG125 T103/A1 E	192021	KG125 T203/A1 E	192038
	160 A	55 kW / 850 A	KG160 T103/A1 E	192045	KG160 T203/A1 E	192052
IP 66 <sup>1</sup> 48 x 48  	20 A	5,5 kW / 120 A	KG10A T103/A2 E	193295	KG10A T203/A2 E	193301
	25 A	7,5 kW / 180 A	KG20A T103/A2 E	192816	KG20A T203/A2 E	192823
	32 A	11 kW / 220 A	KG32A T103/A2 E	192830	KG32A T203/A2 E	192847
64 x 64  	20 A	5,5 kW / 120 A	KG10B T103/A2 E	193431	KG10B T203/A2 E	193448
	25 A	7,5 kW / 180 A	KG20B T103/A2 E	193059	KG20B T203/A2 E	193066
	32 A	11 kW / 220 A	KG32B T103/A2 E	193073	KG32B T203/A2 E	193097
	40 A	15 kW / 300 A	KG41B T103/A2 E	193165	KG41B T203/A2 E	193189
	63 A	22 kW / 350 A	KG64B T103/A2 E	192908	KG64B T203/A2 E	192922
	80 A	30 kW / 560 A	KG80 T103/A2 E	191802	KG80 T203/A2 E	191826
	100 A	37 kW / 650 A	KG100 T103/A2 E	191857	KG100 T203/A2 E	191864
88 x 88	80 A	30 kW / 560 A	KG80C T103/A2 E	192380	KG80C T203/A2 E	192397
	100 A	37 kW / 650 A	KG100C T103/A2 E	192267	KG100C T203/A2 E	192274
	125 A	45 kW / 750 A	KG125 T103/A2 E	192069	KG125 T203/A2 E	192090
	160 A	55 kW / 850 A	KG160 T103/A2 E	192106	KG160 T203/A2 E	192113
	200 A	75 kW / 1100 A	KG210 T103/A3 E	192779	KG210 T203/A3 E	192786
	250 A	90 kW / 1380 A	KG250 T103/A3 E	192694	KG250 T203/A3 E	192717
	315 A	110 kW / 1650 A	KG315 T103/A3 E	192731	KG315 T203/A3 E	192755
130 x 130	315 A	132 kW / 2000 A	C316 T103/A3 E	192670	C316 T203/A3 E	192687

[< back to table of contents >](#)

<sup>1</sup>C316 protection IP 40. Higher protection available on request.



## Main Switches and Main Switches with Emergency Function 3 pole + 2 cam- or rack-operated auxiliary contacts (1 NO,1 NC), for Four Hole Panel Mounting

Auxiliary contacts with special contact systems allow for use in low voltage and current applications as well aggressive environments.

Version	Thermal Current $I_u/I_{th}$	Ratings AC-23A, AC-23B Breaking Capacity 3 x 380 V/440 V	Main Switches	EAN-Code 9004257	Main Switches with Emergency Function	EAN-Code 9004257
Protection Escutcheon plate in mm			Handle black		Handle red Contrasting yellow plate	
IP 66 88 x 88	250 A 315 A	90 kW / 1380 A 110 kW / 1650 A	KG250 T103/A4 E KG315 T103/A4 E	192700 192748	KG250 T203/A4 E KG315 T203/A4 E	192724 192762

## Main Switches and Main Switches with Emergency Function 3 pole + 2 cam-operated auxiliary contacts (1 NO,1 NC), for Single Hole Mounting 22 mm



Auxiliary contacts with special contact systems allow for use in low voltage and current applications as well aggressive environments.

Version	Thermal Current $I_u/I_{th}$	Ratings AC-23A, AC-23B Breaking Capacity 3 x 380 V/440 V	Main Switches	EAN-Code 9004257	Main Switches with Emergency Function	EAN-Code 9004257
Protection Escutcheon plate in mm			Handle black		Handle red Contrasting yellow plate	
IP 66 64 x 64	20 A 25 A 32 A	5,5 kW / 120 A 7,5 kW / 180 A 11 kW / 220 A	KG10B T103/A1 FT2 KG20B T103/A1 FT2 KG32B T103/A1 FT2	193318 192939 192953	KG10B T203/A1 FT2 KG20B T203/A1 FT2 KG32B T203/A1 FT2	193400 192946 192960
IP 66 48 x 48	20 A 25 A 32 A	5,5 kW / 120 A 7,5 kW / 180 A 11 kW / 220 A	KG10A T103/A2 FT2 KG20A T103/A2 FT2 KG32A T103/A2 FT2	193417 192977 193011	KG10A T203/A2 FT2 KG20A T203/A2 FT2 KG32A T203/A2 FT2	193424 192991 193035
64 x 64	20 A 25 A 32 A	5,5 kW / 120 A 7,5 kW / 180 A 11 kW / 220 A	KG10B T103/A2 FT2 KG20B T103/A2 FT2 KG32B T103/A2 FT2	192144 192410 192519	KG10B T203/A2 FT2 KG20B T203/A2 FT2 KG32B T203/A2 FT2	192151 192465 192540

## Main Switches and Main Switches with Emergency Function

### 3 pole + 2 cam-operated auxiliary contacts (1 NO, 1 NC), for Base Mounting with Door Clutch, Padlock Device and Single Hole Mounting 22 mm

Auxiliary contacts with special contact systems allow for use in low voltage and current applications as well aggressive environments.



Version	Thermal Current $I_U/I_{th}$	Ratings AC-23A, AC-23B Breaking Capacity 3 x 380 V/440 V	Main Switches Handle black	EAN-Code 9004257	Main Switches with Emergency Function Handle red Contrasting yellow plate	EAN-Code 9004257
IP 66 48 x 48 	20 A 25 A 32 A 40 A 63 A	5,5 kW / 120 A 7,5 kW / 180 A 11 kW / 220 A 15 kW / 300 A 22 kW / 350 A	KG10A T103/A5 VE KG20A T103/A5 VE KG32A T103/A5 VE KG41 T103/A5 VE KG64 T103/A5 VE	193394 193110 193134 191925 191901	KG10A T203/A5 VE KG20A T203/A5 VE KG32A T203/A5 VE KG41 T203/A5 VE KG64 T203/A5 VE	193257 193127 193141 191932 191918
64 x 64	20 A 25 A 32 A 40 A 63 A 80 A 100 A	5,5 kW / 120 A 7,5 kW / 180 A 11 kW / 220 A 15 kW / 300 A 22 kW / 350 A 30 kW / 560 A 37 kW / 650 A	KG10B T103/A5 VE KG20B T103/A5 VE KG32B T103/A5 VE KG41B T103/A5 VE KG64B T103/A5 VE KG80 T103/A5 VE KG100 T103/A5 VE	191871 192427 192526 192571 192366 191697 191710	KG10B T203/A5 VE KG20B T203/A5 VE KG32B T203/A5 VE KG41B T203/A5 VE KG64B T203/A5 VE KG80 T203/A5 VE KG100 T203/A5 VE	192403 192472 192557 192588 192373 191703 191727
IP 66 64 x 64   Misalignment between the shaft and operator is compensated for by a centering device.	20 A 25 A 32 A 40 A 63 A 80 A 100 A	5,5 kW / 120 A 7,5 kW / 180 A 11 kW / 220 A 15 kW / 300 A 22 kW / 350 A 30 kW / 560 A 37 kW / 650 A	KG10B T103/A6 VE KG20B T103/A6 VE KG32B T103/A6 VE KG41B T103/A6 VE KG64B T103/A6 VE KG80 T103/A6 VE KG100 T103/A6 VE	191888 192434 192533 192632 191963 192182 191987	KG10B T203/A6 VE KG20B T203/A6 VE KG32B T203/A6 VE KG41B T203/A6 VE KG64B T203/A6 VE KG80 T203/A6 VE KG100 T203/A6 VE	191895 192489 192564 192649 191970 192212 192007
IP 66 64 x 64   Misalignment between the shaft and operator is compensated for by a centering device.	20 A 25 A 32 A 40 A 63 A 80 A 100 A	5,5 kW / 120 A 7,5 kW / 180 A 11 kW / 220 A 15 kW / 300 A 22 kW / 350 A 30 kW / 560 A 37 kW / 650 A	KG10B T103/A7 VE KG20B T103/A7 VE KG32B T103/A7 VE KG41B T103/A7 VE KG64B T103/A7 VE KG80 T103/A7 VE KG100 T103/A7 VE	192168 192441 192618 192342 191949 192595 191994	KG10B T203/A7 VE KG20B T203/A7 VE KG32B T203/A7 VE KG41B T203/A7 VE KG64B T203/A7 VE KG80 T203/A7 VE KG100 T203/A7 VE	192175 192496 192625 192359 191956 192601 192014

< back to table of contents >

## Main Switches and Main Switches with Emergency Function

### 3 pole + 2 cam- or rack-operated auxiliary contact (1 NO,1 NC), for Base Mounting with Door Clutch

















Auxiliary contacts with special contact systems allow for use in low voltage and current applications as well aggressive environments.

Version	Thermal Current $I_u/I_{th}$	Ratings AC-23A, AC-23B Breaking Capacity 3 x 380 V/440 V	Main Switches Handle black	EAN-Code 9004257	Main Switches with Emergency Function Handle red Contrasting yellow plate	EAN-Code 9004257	
IP 66/67 64 x 64  	20 A	5,5 kW / 120 A	KG10B T103/A8 VE	191772	KG10B T203/A8 VE	191789	
	25 A	7,5 kW / 180 A	KG20B T103/A8 VE	191659	KG20B T203/A8 VE	191666	
	32 A	11 kW / 220 A	KG32B T103/A8 VE	191673	KG32B T203/A8 VE	191680	
	40 A	15 kW / 300 A	KG41B T103/A8 VE	191758	KG41B T203/A8 VE	191765	
	63 A	22 kW / 350 A	KG64B T103/A8 VE	191734	KG64B T203/A8 VE	191741	
	80 A	30 kW / 560 A	KG80 T103/A8 VE	191550	KG80 T203/A8 VE	191567	
	100 A	37 kW / 650 A	KG100 T103/A8 VE	191536	KG100 T203/A8 VE	191543	
	88 x 88	125 A	45 kW / 750 A	KG125 T103/A8 VE	191574	KG125 T203/A8 VE	191581
	160 A	55 kW / 850 A	KG160 T103/A8 VE	191598	KG160 T203/A8 VE	191604	
	IP 66/67 48 x 48  	20 A	5,5 kW / 120 A	KG10A T103/A9 VE	193264	KG10A T203/A9 VE	193271
25 A		7,5 kW / 180 A	KG20A T103/A9 VE	192984	KG20A T203/A9 VE	193004	
32 A		11 kW / 220 A	KG32A T103/A9 VE	193028	KG32A T203/A9 VE	193042	
64 x 64		20 A	5,5 kW / 120 A	KG10B T103/A9 VE	193387	KG10B T203/A9 VE	193288
		25 A	7,5 kW / 180 A	KG20B T103/A9 VE	192458	KG20B T203/A9 VE	192502
		32 A	11 kW / 220 A	KG32B T103/A9 VE	193080	KG32B T203/A9 VE	193103
		40 A	15 kW / 300 A	KG41B T103/A9 VE	193219	KG41B T203/A9 VE	193226
		63 A	22 kW / 350 A	KG64B T103/A9 VE	191512	KG64B T203/A9 VE	191529
		80 A	30 kW / 560 A	KG80 T103/A9 VE	192199	KG80 T203/A9 VE	192229
		100 A	37 kW / 650 A	KG100 T103/A9 VE	192243	KG100 T203/A9 VE	192250
IP 66 88 x 88   <p>Using the device the electrical panel may be opened only when the switch is in the OFF position and no padlock is fitted. Note: Only in the ON position can knowledgeable personnel using a simple tool to defeat the interlock. The M700's flexibility allows for successful installation with as much as + or - 5 mm of misalignment between the shaft and door.</p>	25 A	7,5 kW / 180 A	KG20B T103/B1 VE	193479	KG20B T203/B1 VE	193486	
	32 A	11 kW / 220 A	KG32B T103/B1 VE	193493	KG32B T203/B1 VE	193509	
	40 A	15 kW / 300 A	KG41B T103/B1 VE	193196	KG41B T203/B1 VE	193202	
	63 A	22 kW / 350 A	KG64B T103/B1 VE	193233	KG64B T203/B1 VE	193240	
	80 A	30 kW / 560 A	KG80 T103/B1 VE	192205	KG80 T203/B1 VE	192236	
	100 A	37 kW / 650 A	KG100 T103/B1 VE	192656	KG100 T203/B1 VE	192663	
	125 A	45 kW / 750 A	KG125 T103/B1 VE	192076	KG125 T203/B1 VE	192083	
	160 A	55 kW / 850 A	KG160 T103/B1 VE	192120	KG160 T203/B1 VE	192137	
	200 A	75 kW / 1100 A	KG210 T103/B2 VE	192793	KG210 T203/B2 VE	192809	
	250 A	90 kW / 1380 A	KG250 T103/B2 VE	193349	KG250 T203/B2 VE	193356	
	315 A	110 kW / 1650 A	KG315 T103/B2 VE	193363	KG315 T203/B2 VE	193370	
	315 A	132 kW / 2000 A	C316 T103/B2 VE	193455	C316 T203/B2 VE	193462	

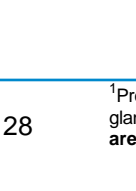
[< back to table of contents >](#)

# Maintenance and Safety Switches

**3 pole,**  
**in Plastic Enclosure** (conduit entries for metric threads)

Version		Thermal Current	Ratings AC-23A, AC-23B Breaking Capacity 3 x 380 V/440 V	Main Switches Handle electro-gray  Handle black  		EAN-Code	Main Switches with Emergency Function Handle red Contrasting yellow plate		EAN-Code	
Protection IP 66/67	Padlock Device	$I_{the}$				9004257			9004257	
		20 A	5,5 kW / 120 A	KG10	T103/33 KS51V	06743 5	KG10	T203/33 KS51V	06773 2	
		25 A	7,5 kW / 180 A	KG20	T103/33 KS51V	06744 2	KG20	T203/33 KS51V	06774 9	
		20 A	5,5 kW / 120 A	KG10	T103/75 KS51	06745 9	KG10	T203/75 KS51	06775 6	
		25 A	7,5 kW / 180 A	KG20	T103/75 KS51	06746 6	KG20	T203/75 KS51	06776 3	
		25 A	7,5 kW / 180 A	KG20	T103/33 KL51V	06747 3	KG20	T203/33 KL51V	06777 0	
		32 A	11 kW / 220 A	KG32	T103/33 KL51V <sup>2</sup>	06748 0	KG32	T203/33 KL51V <sup>2</sup>	06778 7	
		40 A	15 kW / 300 A	KG41	T103/33 KL11V	06749 7	KG41	T203/33 KL11V	06779 4	
		63 A	22 kW / 350 A	KG64	T103/33 KL11V	06750 3	KG64	T203/33 KL11V	06780 0	
		80 A	30 kW / 560 A	KG80	T103/33 KL71V	07454 9	KG80	T203/33 KL71V	07455 6	
		100 A	37 kW / 650 A	KG100	T103/33 KL71V	07456 3	KG100	T203/33 KL71V	07457 0	
		25 A	7,5 kW / 180 A	KG20	T103/75 KL51	06753 4	KG20	T203/75 KL51	06783 1	
		32 A	11 kW / 220 A	KG32	T103/75 KL51 <sup>2</sup>	06754 1	KG32	T203/75 KL51 <sup>2</sup>	06784 8	
		40 A	15 kW / 300 A	KG41	T103/75 KL11	06755 8	KG41	T203/75 KL11	06785 5	
		63 A	22 kW / 350 A	KG64	T103/75 KL11	06756 5	KG64	T203/75 KL11	06786 2	
		80 A	30 kW / 560 A	KG80	T103/75 KL71	07279 8	KG80	T203/75 KL71	07281 1	
		100 A	37 kW / 650 A	KG100	T103/75 KL71	07280 4	KG100	T203/75 KL71	07282 8	
		125 A	45 kW / 750 A	KG125	T103/34 STM <sup>1</sup>	06759 6	KG125	T203/34 STM <sup>1</sup>	06789 3	
		160 A	55 kW / 850 A	KG160	T103/34 STM <sup>1</sup>	06760 2	KG160	T203/34 STM <sup>1</sup>	06790 9	
		125 A	45 kW / 750 A	KG125	T103/76 STM <sup>1</sup>	06761 9	KG125	T203/76 STM <sup>1</sup>	06791 6	
		160 A	55 kW / 850 A	KG160	T103/76 STM <sup>1</sup>	06762 6	KG160	T203/76 STM <sup>1</sup>	06792 3	
		250 A	90 kW / 1380 A	KG250	T103/36 STM	06763 3	KG250	T203/36 STM	06793 0	
		315 A	110 kW / 1650 A	KG315	T103/36 STM <sup>3</sup>	06764 0	KG315	T203/36 STM <sup>3</sup>	06794 7	
		315 A	132 kW / 2000 A	C316	T103/37 STM <sup>3</sup>	06765 7	C316	T203/37 STM <sup>3</sup>	06795 4	
						<b>Oversized Wiring Space</b>				
		125 A	45 kW / 750 A	KG125	T103/38 STM	06766 4	KG125	T203/38 STM	06796 1	
		160 A	55 kW / 850 A	KG160	T103/38 STM	06767 1	KG160	T203/38 STM	06797 8	
		125 A	45 kW / 750 A	KG125	T103/36 STM	06768 8	KG125	T203/36 STM	06798 5	
		160 A	55 kW / 850 A	KG160	T103/36 STM	06769 5	KG160	T203/36 STM	06799 2	
		250 A	90 kW / 1380 A	KG250	T103/39 STM <sup>3</sup>	06770 1	KG250	T203/39 STM <sup>3</sup>	06800 5	
		315 A	110 kW / 1650 A	KG315	T103/39 STM <sup>3</sup>	06771 8	KG315	T203/39 STM <sup>3</sup>	06801 2	
		315 A	132 kW / 2000 A	C316	T103/39 STM <sup>3</sup>	06772 5	C316	T203/39 STM <sup>3</sup>	06802 9	

















[< back to table of contents >](#)

<sup>1</sup>Protection IP 65. <sup>2</sup>For conduit entries M25 in place of M20 the ordering data changes from KL51V to KL11V and from KL51 to KL11. <sup>3</sup>Switches with cable glands. To meet the conditions of EMC (Electro Magnetic Compatibility) for connection of frequency regulated motors, maintenance switches are available with shield clips. These clips are used to continue the cable shield circuit through the enclosure.

# Maintenance and Safety Switches

**3 pole + 2 cam- or rack-operated auxiliary contacts (1 NO, 1 NC),  
in Plastic Enclosure** (conduit entries for metric threads)

Auxiliary contacts with special contact systems allow for use in low voltage and current applications as well aggressive environments.

















Version		Thermal Current	Ratings AC-23A, AC-23B Breaking Capacity	Main Switches		EAN-Code	Main Switches with Emergency Function		EAN-Code
Protection IP 66/67	Padlock Device	$I_{the}$	3 x 380 V/440 V	Handle electro-gray 		9004257	Handle red Contrasting yellow plate		9004257
				Handle black  					
		20 A	5,5 kW / 120 A	KG10	T103/40 KS51V	06803 6	KG10	T203/40 KS51V	06804 3
		20 A	5,5 kW / 120 A	KG10	T103/78 KS51	06805 0	KG10	T203/78 KS51	06806 7
		25 A	7,5 kW / 180 A	KG20	T103/40 KL51V	06807 4	KG20	T203/40 KL51V	06808 1
		32 A	11 kW / 220 A	KG32	T103/40 KL51V <sup>2</sup>	06809 8	KG32	T203/40 KL51V <sup>2</sup>	06810 4
		40 A	15 kW / 300 A	KG41	T103/40 KL11V	06811 1	KG41	T203/40 KL11V	06812 8
		63 A	22 kW / 350 A	KG64	T103/40 KL11V	06813 5	KG64	T203/40 KL11V	06814 2
		80 A	30 kW / 560 A	KG80	T103/40 KL71V	07458 7	KG80	T203/40 KL71V	07459 4
		100 A	37 kW / 650 A	KG100	T103/40 KL71V	07460 0	KG100	T203/40 KL71V	07461 7
		25 A	7,5 kW / 180 A	KG20	T103/78 KL51	06819 7	KG20	T203/78 KL51	06820 3
		32 A	11 kW / 220 A	KG32	T103/78 KL51 <sup>2</sup>	06821 0	KG32	T203/78 KL51 <sup>2</sup>	06822 7
		40 A	15 kW / 300 A	KG41	T103/78 KL11	06823 4	KG41	T203/78 KL11	06824 1
		63 A	22 kW / 350 A	KG64	T103/78 KL11	06825 8	KG64	T203/78 KL11	06826 5
		80 A	30 kW / 560 A	KG80	T103/78 KL71	06827 2	KG80	T203/78 KL71	06828 9
		100 A	37 kW / 650 A	KG100	T103/78 KL71	06829 6	KG100	T203/78 KL71	06830 2
		125 A	45 kW / 750 A	KG125	T103/41 STM <sup>1</sup>	06831 9	KG125	T203/41 STM <sup>1</sup>	06832 6
		160 A	55 kW / 850 A	KG160	T103/41 STM <sup>1</sup>	06833 3	KG160	T203/41 STM <sup>1</sup>	06834 0
		125 A	45 kW / 750 A	KG125	T103/79 STM <sup>1</sup>	06835 7	KG125	T203/79 STM <sup>1</sup>	06836 4
		160 A	55 kW / 850 A	KG160	T103/79 STM <sup>1</sup>	06837 1	KG160	T203/79 STM <sup>1</sup>	06838 8
		250 A	90 kW / 1380 A	KG250	T103/43 STM	06839 5	KG250	T203/43 STM	06840 1
315 A	110 kW/1650 A	KG315	T103/43 STM <sup>3</sup>	06841 8	KG315	T203/43 STM <sup>3</sup>	06842 5		
315 A	132 kW/2000 A	C316	T103/44 STM <sup>3</sup>	06843 2	C316	T203/44 STM <sup>3</sup>	06844 9		
				<b>Oversized Wiring Space</b>				<b>Oversized Wiring Space</b>	
		125 A	45 kW / 750 A	KG125	T103/45 STM	06845 6	KG125	T203/45 STM	06846 3
		160 A	55 kW / 850 A	KG160	T103/45 STM	06847 0	KG160	T203/45 STM	06848 7
		125 A	45 kW / 750 A	KG125	T103/43 STM	06849 4	KG125	T203/43 STM	06850 0
		160 A	55 kW / 850 A	KG160	T103/43 STM	06851 7	KG160	T203/43 STM	06852 4
		250 A	90 kW / 1380 A	KG250	T103/46 STM <sup>3</sup>	06853 1	KG250	T203/46 STM <sup>3</sup>	06854 8
315 A	110 kW/1650 A	KG315	T103/46 STM <sup>3</sup>	06855 5	KG315	T203/46 STM <sup>3</sup>	06856 2		
315 A	132 kW/2000 A	C316	T103/46 STM <sup>3</sup>	06857 9	C316	T203/46 STM <sup>3</sup>	06858 6		

[< back to table of contents >](#)

<sup>1</sup>Protection IP 65. <sup>2</sup>For conduit entries M25 in place of M20 the ordering data changes from KL51V to KL11V and from KL51 to KL11. <sup>3</sup>Switches with cable glands. To meet the conditions of EMC (Electro Magnetic Compatibility) for connection of frequency regulated motors, maintenance switches are available with shield clips. These clips are used to continue the cable shield circuit through the enclosure.

# Maintenance and Safety Switches

## 4 pole, in Plastic Enclosure (conduit entries for metric threads)

Version	Thermal Current	Ratings AC-23A, AC-23B Breaking Capacity	Main Switches	EAN-Code	Main Switches with Emergency Function	EAN-Code	
Protection IP 66/67	Padlock Device	$I_{the}$	Handle electro-gray  Handle black  	9004257	Handle red Contrasting yellow plate	9004257	
		20 A	5,5 kW / 120 A	KG10 T104/33 KS51V	06859 3	KG10 T204/33 KS51V	06860 9
		16 A	7,5 kW / 160 A	KH16 T104/33 KS51V	08805 8	KH16 T204/33 KS51V	08807 2
		20 A	5,5 kW / 120 A	KG10 T104/75 KS51	06863 0	KG10 T204/75 KS51	06864 7
		16 A	7,5 kW / 160 A	KH16 T104/75 KS51	08806 5	KH16 T204/75 KS51	08808 9
		20 A	10 kW / 200 A	KH20 T104/33 KL11V	08809 6	KH20 T204/33 KL11V	08810 2
		25 A	12 kW / 250 A	KH25 T104/33 KL11V	08811 9	KH25 T204/33 KL11V	08812 6
		32 A	16 kW / 300 A	KH32 T104/33 KL11V	08813 3	KH32 T204/33 KL11V	08837 9
		40 A	20 kW / 380 A	KH40 T104/33 KL11V	08814 0	KH40 T204/33 KL11V	08838 6
		63 A	30 kW / 500 A	KH63 T104/33 KL71V	08815 7	KH63 T204/33 KL71V	08839 3
		80 A	40 kW / 630 A	KH80 T104/33 KL71V	08816 4	KH80 T204/33 KL71V	08840 9
		100 A	37 kW / 650 A	KG100 T104/33 KL71V	07464 8	KG100 T204/33 KL71V	07465 5
		20 A	10 kW / 200 A	KH20 T104/75 KL11	08817 1	KH20 T204/75 KL11	08841 6
		25 A	12 kW / 250 A	KH25 T104/75 KL11	08818 8	KH25 T204/75 KL11	08842 3
		32 A	16 kW / 300 A	KH32 T104/75 KL11	08819 5	KH32 T204/75 KL11	08843 0
		40 A	20 kW / 380 A	KH40 T104/75 KL11	08820 1	KH40 T204/75 KL11	08844 7
		63 A	30 kW / 500 A	KH63 T104/75 KL71	08861 4	KH63 T204/75 KL71	08845 4
		80 A	40 kW / 630 A	KH80 T104/75 KL71	08862 1	KH80 T204/75 KL71	08846 1
		100 A	37 kW / 650 A	KG100 T104/75 KL71	06889 0	KG100 T204/75 KL71	06890 6
		125 A	45 kW / 750 A	KG125 T104/35 STM	06891 3	KG125 T204/35 STM	06892 0
		160 A	55 kW / 850 A	KG160 T104/35 STM	06893 7	KG160 T204/35 STM	06894 4
		125 A	45 kW / 750 A	KG125 T104/77 STM	06895 1	KG125 T204/77 STM	06896 8
		160 A	55 kW / 850 A	KG160 T104/77 STM	06897 5	KG160 T204/77 STM	06898 2
		250 A	90 kW / 1380 A	KG250 T104/36 STM	06899 9	KG250 T204/36 STM	06900 2
		315 A	110 kW / 1650 A	KG315 T104/36 STM <sup>1</sup>	06901 9	KG315 T204/36 STM <sup>1</sup>	06902 6
315 A	132 kW / 2000 A	C316 T104/37 STM <sup>1</sup>	06903 3	C316 T204/37 STM <sup>1</sup>	06904 0		
			<b>Oversized Wiring Space</b>				
		125 A	45 kW / 750 A	KG125 T104/38 STM	06905 7	KG125 T204/38 STM	06906 4
		160 A	55 kW / 850 A	KG160 T104/38 STM	06907 1	KG160 T204/38 STM	06908 8
		125 A	45 kW / 750 A	KG125 T104/36 STM	06909 5	KG125 T204/36 STM	06910 1
		160 A	55 kW / 850 A	KG160 T104/36 STM	06911 8	KG160 T204/36 STM	06912 5
		250 A	90 kW / 1380 A	KG250 T104/47 STM <sup>1</sup>	06913 2	KG250 T204/47 STM <sup>1</sup>	06914 9
		315 A	110 kW / 1650 A	KG315 T104/47 STM <sup>1</sup>	06915 6	KG315 T204/47 STM <sup>1</sup>	06916 3
315 A	132 kW / 2000 A	C316 T104/39 STM <sup>1</sup>	06917 0	C316 T204/39 STM <sup>1</sup>	06918 7		

[< back to table of contents >](#)

















<sup>1</sup>Switches with cable glands.

To meet the conditions of EMC (Electro Magnetic Compatibility) for connection of frequency regulated motors, maintenance switches are available with shield clips. These clips are used to continue the cable shield circuit through the enclosure.

# Maintenance and Safety Switches

**4 pole + 2 cam- or rack-operated auxiliary contacts (1 NO, 1 NC),  
in Plastic Enclosure** (conduit entries for metric threads)

Auxiliary contacts with special contact systems allow for use in low voltage and current applications as well aggressive environments.













Version		Thermal Current	Ratings AC-23A, AC-23B Breaking Capacity	Main Switches		EAN-Code	Main Switches with Emergency Function		EAN-Code	
Protection IP 66/67	Padlock Device	$I_{the}$	3 x 380 V/440 V	Handle electro-gray 		9004257	Handle red Contrasting yellow plate		9004257	
				Handle black 						
		20 A	5,5 kW / 120 A	KG10	T104/40 KS51V	06919 4	KG10	T204/40 KS51V	06920 0	
		16 A	7,5 kW / 160 A	KH16	T104/40 KS51V	08823 2	KH16	T204/40 KS51V	08847 8	
		20 A	5,5 kW / 120 A	KG10	T104/78 KS51	06921 7	KG10	T204/78 KS51	06922 4	
		16 A	7,5 kW / 160 A	KH16	T104/78 KS51	08824 9	KH16	T204/78 KS51	08848 5	
		20 A	10 kW / 200 A	KH20	T104/40 KL11V	08825 6	KH20	T204/40 KL11V	08849 2	
		25 A	12 kW / 250 A	KH25	T104/40 KL11V	08826 3	KH25	T204/40 KL11V	08850 8	
		32 A	16 kW / 300 A	KH32	T104/40 KL11V	08827 0	KH32	T204/40 KL11V	08851 5	
		40 A	20 kW / 380 A	KH40	T104/40 KL11V	08828 7	KH40	T204/40 KL11V	08852 2	
		63 A	30 kW / 500 A	KH63	T104/40 KL71V	08829 4	KH63	T204/40 KL71V	08853 9	
		80 A	40 kW / 630 A	KH80	T104/40 KL71V	08830 0	KH80	T204/40 KL71V	08854 6	
		100 A	37 kW / 650 A	KG100	T104/40 KL71V	07468 6	KG100	T204/40 KL71V	07469 3	
		20 A	10 kW / 200 A	KH20	T104/78 KL11	08831 7	KH20	T204/78 KL11	08855 3	
		25 A	12 kW / 250 A	KH25	T104/78 KL11	08832 4	KH25	T204/78 KL11	08856 0	
		32 A	16 kW / 300 A	KH32	T104/78 KL11	08833 1	KH32	T204/78 KL11	08857 7	
		40 A	20 kW / 380 A	KH40	T104/78 KL11	08834 8	KH40	T204/78 KL11	08858 4	
		63 A	30 kW / 500 A	KH63	T104/78 KL71	08835 5	KH63	T204/78 KL71	08859 1	
		80 A	40 kW / 630 A	KH80	T104/78 KL71	08836 2	KH80	T204/78 KL71	08860 7	
		100 A	37 kW / 650 A	KG100	T104/78 KL71	06945 3	KG100	T204/78 KL71	06946 0	
		125 A	45 kW / 750 A	KG125	T104/42 STM	06947 7	KG125	T204/42 STM	06948 4	
		160 A	55 kW / 850 A	KG160	T104/42 STM	06949 1	KG160	T204/42 STM	06950 7	
		125 A	45 kW / 750 A	KG125	T104/80 STM	06951 4	KG125	T204/80 STM	06952 1	
		160 A	55 kW / 850 A	KG160	T104/80 STM	06953 8	KG160	T204/80 STM	06954 5	
		250 A	90 kW / 1380 A	KG250	T104/43 STM	06955 2	KG250	T204/43 STM	06956 9	
		315 A	110 kW / 1650 A	KG315	T104/43 STM <sup>1</sup>	06957 6	KG315	T204/43 STM <sup>1</sup>	06958 3	
		315 A	132 kW / 2000 A	C316	T104/44 STM <sup>1</sup>	06959 0	C316	T204/44 STM <sup>1</sup>	06960 6	
				<b>Oversized Wiring Space</b>				<b>Oversized Wiring Space</b>		
		125 A	45 kW / 750 A	KG125	T104/45 STM	06961 3	KG125	T204/45 STM	06962 0	
		160 A	55 kW / 850 A	KG160	T104/45 STM	06963 7	KG160	T204/45 STM	06964 4	
		125 A	45 kW / 750 A	KG125	T104/43 STM	06965 1	KG125	T204/43 STM	06966 8	
		160 A	55 kW / 850 A	KG160	T104/43 STM	06967 5	KG160	T204/43 STM	06968 2	
		250 A	90 kW / 1380 A	KG250	T104/48 STM <sup>1</sup>	06969 9	KG250	T204/48 STM <sup>1</sup>	06970 5	
		315 A	110 kW / 1650 A	KG315	T104/48 STM <sup>1</sup>	06971 2	KG315	T204/48 STM <sup>1</sup>	06972 9	
		315 A	132 kW / 2000 A	C316	T104/46 STM <sup>1</sup>	06973 6	C316	T204/46 STM <sup>1</sup>	06974 3	

<sup>1</sup>Switches with cable glands.

To meet the conditions of EMC (Electro Magnetic Compatibility) for connection of frequency regulated motors, maintenance switches are available with shield clips. These clips are used to continue the cable shield circuit through the enclosure.

## Maintenance and Safety Switches

### 6 pole, in Plastic Enclosure (conduit entries for metric threads)

Version	Thermal Current	Ratings AC-23A, AC-23B Breaking Capacity	Main Switches	EAN-Code	Main Switches with Emergency Function	EAN-Code	
Protection IP 66/67	$I_{the}$	3 x 380 V/440 V	Handle electro-gray Handle black	9004257	Handle red Contrasting yellow plate	9004257	
		20 A	5,5 kW / 120 A	KG10 T106/33 KS51V	06975 0	KG10 T206/33 KS51V	06976 7
		20 A	5,5 kW / 120 A	KG10 T106/75 KS51	06977 4	KG10 T206/75 KS51	06978 1
		25 A	7,5 kW / 180 A	KG20B T106/33 KL11V	06979 8	KG20B T206/33 KL11V	06980 4
		32 A	11 kW / 220 A	KG32B T106/33 KL11V	06981 1	KG32B T206/33 KL11V	06982 8
		40 A	15 kW / 300 A	KG41B T106/33 KL71V	07470 9	KG41B T206/33 KL71V	07471 6
		63 A	22 kW / 350 A	KG64B T106/33 KL71V	07472 3	KG64B T206/33 KL71V	07473 0
		25 A	7,5 kW / 180 A	KG20B T106/75 KL11	06987 3	KG20B T206/75 KL11	06988 0
		32 A	11 kW / 220 A	KG32B T106/75 KL11	06989 7	KG32B T206/75 KL11	06990 3
		40 A	15 kW / 300 A	KG41B T106/75 KL71	06991 0	KG41B T206/75 KL71	06992 7
		63 A	22 kW / 350 A	KG64B T106/75 KL71	06993 4	KG64B T206/75 KL71	06994 1
		80 A	30 kW / 560 A	KG80C T106/34 STM <sup>1</sup>	06995 8	KG80C T206/34 STM <sup>1</sup>	06996 5
		100 A	37 kW / 650 A	KG100C T106/34 STM <sup>1</sup>	06997 2	KG100C T206/34 STM <sup>1</sup>	06998 9
		125 A	45 kW / 750 A	KG125 T106/84 STM <sup>1</sup>	06999 6	KG125 T206/84 STM <sup>1</sup>	07000 8
		160 A	55 kW / 850 A	KG160 T106/84 STM <sup>1</sup>	07001 5	KG160 T206/84 STM <sup>1</sup>	07002 2
		80 A	30 kW / 560 A	KG80C T106/76 STM <sup>1</sup>	07003 9	KG80C T206/76 STM <sup>1</sup>	07004 6
		100 A	37 kW / 650 A	KG100C T106/76 STM <sup>1</sup>	07005 3	KG100C T206/76 STM <sup>1</sup>	07006 0
		125 A	45 kW / 750 A	KG125 T106/85 STM <sup>1</sup>	07007 7	KG125 T206/85 STM <sup>1</sup>	07008 4
		160 A	55 kW / 850 A	KG160 T106/85 STM <sup>1</sup>	07009 1	KG160 T206/85 STM <sup>1</sup>	07010 7
		275 A	132 kW/2000 A	C316 T106/39 STM <sup>2</sup>	07011 4	C316 T206/39 STM <sup>2</sup>	07012 1
				<b>Oversized Wiring Space</b>		<b>Oversized Wiring Space</b>	
		125 A	45 kW / 750 A	KG125 T106/86 STM <sup>1</sup>	07013 8	KG125 T206/86 STM <sup>1</sup>	07014 5
		160 A	55 kW / 850 A	KG160 T106/86 STM <sup>1</sup>	07015 2	KG160 T206/86 STM <sup>1</sup>	07016 9
		125 A	45 kW / 750 A	KG125 T106/87 STM <sup>1</sup>	07017 6	KG125 T206/87 STM <sup>1</sup>	07018 3
		160 A	55 kW / 850 A	KG160 T106/87 STM <sup>1</sup>	07019 0	KG160 T206/87 STM <sup>1</sup>	07020 6
		275 A	132 kW/2000 A	C316 T106/47 STM <sup>2</sup>	07021 3	C316 T206/47 STM <sup>2</sup>	07022 0

[< back to table of contents >](#)

<sup>1</sup>Protection IP 65. <sup>2</sup>Switches with cable glands.

















To meet the conditions of EMC (Electro Magnetic Compatibility) for connection of frequency regulated motors, maintenance switches are available with shield clips. These clips are used to continue the cable shield circuit through the enclosure.



# Maintenance and Safety Switches

**6 pole + 2 cam-operated auxiliary contacts (1 NO, 1 NC),  
in Plastic Enclosure (conduit entries for metric threads)**

Auxiliary contacts with special contact systems allow for use in low voltage and current applications as well aggressive environments.

Version	Thermal Current	Ratings AC-23A, AC-23B	Main Switches	EAN-Code	Main Switches with Emergency Function	EAN-Code
Protection IP 66/67 Padlock Device $I_{the}$		<b>Breaking Capacity</b> 3 x 380 V/440 V	Handle electro-gray  Handle black 	9004257	Handle red Contrasting yellow plate	9004257
 	20 A	5,5 kW / 120 A	KG10 T106/40 KS51V	07023 7	KG10 T206/40 KS51V	07024 4
 	25 A	7,5 kW / 180 A	KG20B T106/40 KL11V	07025 1	KG20B T206/40 KL11V	07026 8
	32 A	11 kW / 220 A	KG32B T106/40 KL11V	07027 5	KG32B T206/40 KL11V	07028 2
	40 A	15 kW / 300 A	KG41B T106/40 KL71V	07474 7	KG41B T206/40 KL71V	07475 4
	63 A	22 kW / 350 A	KG64B T106/40 KL71V	07476 1	KG64B T206/40 KL71V	07477 8
 	25 A	7,5 kW / 180 A	KG20B T106/78 KL11	07033 6	KG20B T206/78 KL11	07034 3
	32 A	11 kW / 220 A	KG32B T106/78 KL11	07035 0	KG32B T206/78 KL11	07036 7
	40 A	15 kW / 300 A	KG41B T106/78 KL71	07037 4	KG41B T206/78 KL71	07038 1
	63 A	22 kW / 350 A	KG64B T106/78 KL71	07039 8	KG64B T206/78 KL71	07040 4
 	80 A	30 kW / 560 A	KG80C T106/41 STM <sup>1</sup>	07041 1	KG80C T206/41 STM <sup>1</sup>	07042 8
	100 A	37 kW / 650 A	KG100C T106/41 STM <sup>1</sup>	07043 5	KG100C T206/41 STM <sup>1</sup>	07044 2
	125 A	45 kW / 750 A	KG125 T106/88 STM <sup>1</sup>	07045 9	KG125 T206/88 STM <sup>1</sup>	07046 6
	160 A	55 kW / 850 A	KG160 T106/88 STM <sup>1</sup>	07047 3	KG160 T206/88 STM <sup>1</sup>	07048 0
 	80 A	30 kW / 560 A	KG80C T106/79 STM <sup>1</sup>	07049 7	KG80C T206/79 STM <sup>1</sup>	07050 3
	100 A	37 kW / 650 A	KG100C T106/79 STM <sup>1</sup>	07051 0	KG100C T206/79 STM <sup>1</sup>	07052 7
	125 A	45 kW / 750 A	KG125 T106/89 STM <sup>1</sup>	07053 4	KG125 T206/89 STM <sup>1</sup>	07054 1
	160 A	55 kW / 850 A	KG160 T106/89 STM <sup>1</sup>	07055 8	KG160 T206/89 STM <sup>1</sup>	07056 5
	275 A	132 kW/2000 A	C316 T106/46 STM <sup>2</sup>	07057 2	C316 T206/46 STM <sup>2</sup>	07058 9
			<b>Oversized Wiring Space</b>		<b>Oversized Wiring Space</b>	
 	125 A	45 kW / 750 A	KG125 T106/90 STM <sup>1</sup>	07059 6	KG125 T206/90 STM <sup>1</sup>	07060 2
	160 A	55 kW / 850 A	KG160 T106/90 STM <sup>1</sup>	07061 9	KG160 T206/90 STM <sup>1</sup>	07062 6
 	125 A	45 kW / 750 A	KG125 T106/91 STM <sup>1</sup>	07063 3	KG125 T206/91 STM <sup>1</sup>	07064 0
	160 A	55 kW / 850 A	KG160 T106/91 STM <sup>1</sup>	07065 7	KG160 T206/91 STM <sup>1</sup>	07066 4
	275 A	132 kW/2000 A	C316 T106/48 STM <sup>2</sup>	07067 1	C316 T206/48 STM <sup>2</sup>	07068 8



[< back to table of contents >](#)

<sup>1</sup>Protection IP 65. <sup>2</sup>Switches with cable glands.

To meet the conditions of EMC (Electro Magnetic Compatibility) for connection of frequency regulated motors, maintenance switches are available with shield clips. These clips are used to continue the cable shield circuit through the enclosure.

# Switch Disconnectors $\bigcirc - |$

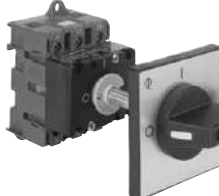
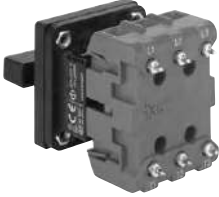

## 3 pole, Types of Mounting

Technical Data		KG20A KG32A KG10A KG20B KG32B KG41 KG64 KG80 KG100 KG10B KG21A <sup>2</sup> KG33A <sup>2</sup> KG41B KG64B KG80C KG100C KG125 KG160 KG210 KG250 KG315 C316														
Ratings																
3 x 380 V/440 V																
AC-23A, AC-23B kW		5,5	7,5	11	15	22	30	37	45	55	75	90	110	132		
AC-3 kW		3,7	5,5	7,5	11	18,5	22	30	37	45	55	55	75	55		
Thermal Current I <sub>U</sub> /I <sub>th</sub> A		20	25	32	40	63	80	100	125	160	200	250	315	315		
Version Protection	Four Hole Panel Mounting	EAN-Code	Version Protection	Base Mounting	EAN-Code											
IP 66 <sup>1</sup> 	KG10A T303 E KG10B T303 E KG20A T303 E KG20B T303 E KG32A T303 E KG32B T303 E KG41 T303 E KG41B T303 E KG64 T303 E KG64B T303 E KG80 T303 E KG80C T303 E KG100 T303 E KG100C T303 E KG125 T303 E KG160 T303 E KG210 T303 E KG250 T303 E KG315 T303 E C316 T303 E	9004257	IP 40 	KG10A T303 VE KG10B T303 VE KG20A T303 VE KG20B T303 VE KG32A T303 VE KG32B T303 VE KG41 T303 VE KG41B T303 VE KG64 T303 VE KG64B T303 VE KG80 T303 VE KG80C T303 VE KG100 T303 VE KG100C T303 VE KG125 T303 VE KG160 T303 VE KG210 T303 VE KG250 T303 VE KG315 T303 VE C316 T303 VE	9004257											
						IP 66 	<b>Single Hole Mounting 22 mm</b>  KG10A T303 FT2 KG20A T303 FT2 KG32A T303 FT2	02602 9 02603 6 02604 3	IP 40 	and shaft extension  KG10A T303/57 VE KG10B T303/57 VE KG20A T303/57 VE KG20B T303/57 VE KG32A T303/57 VE KG32B T303/57 VE KG41B T303/57 VE KG64B T303/57 VE KG80 T303/57 VE KG80C T303/57 VE KG100 T303/57 VE KG100C T303/57 VE KG125 T303/57 VE KG160 T303/57 VE KG210 T303/57 VE KG250 T303/57 VE KG315 T303/57 VE C316 T303/57 VE	01289 3 01287 9 00820 9 00821 6 00822 3 00823 0 00824 7 00825 4 00826 1 00827 8 00828 5 00829 2 00830 8 00831 5 00833 9 00834 6 08371 8 00836 0 00837 7 00838 4					
												On request 	<b>Direct-mounting on Printed Circuit Board</b>  KG21A T303 E KG33A T303 E	03234 1 03235 8		

[< back to table of contents >](#)

<sup>1</sup>C316 protection IP 40. Higher protection available on request. <sup>2</sup>Further technical data for special applications on printed circuit boards on request.



## Switch Disconnectors $\bigcirc - |$ 3 pole, Types of Mounting

Technical Data		KG10A	KG20A	KG32A	KG41	KG64	KG80	KG100	
<b>Ratings</b> 3 x 380 V/440 V AC-23A, AC-23B		kW	5,5	7,5	11	15	22	30	37
AC-3		kW	3,7	5,5	7,5	11	18,5	22	30
Thermal Current $I_U/I_{th}$		A	20	25	32	40	63	80	100
Version	Base Mounting for Track	EAN-Code	Version				Base Mounting for Track	EAN-Code	
		9004257						9004257	
	Esc. plate for 45 mm standard knock-out						and padlock device for padlocks		
	KG10A T303 VE21	01288 6					KG10A T303/58 VE21	01291 6	
	KG20A T303 VE2	00856 8					KG20A T303/58 VE2	00862 9	
	KG32A T303 VE2	00857 5					KG32A T303/58 VE2	00863 6	
	KG41 T303 VE2	00858 2					KG41 T303/58 VE2	00864 3	
	KG64 T303 VE2	00859 9					KG64 T303/58 VE2	00865 0	
	KG80 T303 VE2	00860 5					KG80 T303/58 VE2	00866 7	
	KG100 T303 VE2	00861 2					KG100 T303/58 VE2	00867 4	

[< back to table of contents >](#)

## Switch Disconnectors $\bigcirc - |$ 3 pole + Ground Terminal



## Switch Disconnectors $\bigcirc - |$ 3 pole + Neutral Terminal

Technical Data		KH16	KH20	KH25	KH32	KH40	KH63	KH80	
<b>Ratings</b> 3 x 380 V/440 V AC-23A, AC-23B		kW	7,5	10	12	16	20	30	40
AC-3		kW	5,5	6,5	7,5	11	15	22	30
Thermal Current $I_U/I_{th}$		A	16	20	25	32	40	63	80
Version	Four Hole Panel Mounting	EAN-Code	Version				Four Hole Panel Mounting	EAN-Code	
Protection		9004257	Protection					9004257	
	IP 66								
	KH16 T300 E	09313 7	IP 66				KH16 T307 E	09303 8	
	KH16B T300 E	09314 4					KH16B T307 E	09304 5	
	KH20 T300 E	09315 1					KH20 T307 E	09305 2	
	KH20B T300 E	09316 8					KH20B T307 E	09306 9	
	KH25 T300 E	09317 5					KH25 T307 E	09307 6	
	KH25B T300 E	09318 2					KH25B T307 E	09308 3	
	KH32 T300 E	09319 9					KH32 T307 E	09309 0	
	KH40 T300 E	09320 5					KH40 T307 E	09310 6	
	KH63 T300 E	09321 2					KH63 T307 E	09311 3	
KH80 T300 E	09322 9					KH80 T307 E	09312 0		

<sup>1</sup>Further technical data for special applications on printed circuit boards on request.

## Switch Disconnectors — |





### 4 pole, Types of Mounting

Technical Data		KH16 KH20 KH25 KH16B KH20B KH25B KH32 KH40 KH63 KH80 KG80 KG100 KG80C KG100C KG125 KG160 KG210 KG250 KG315 C316															
Ratings																	
3 x 380 V/440 V																	
AC-23A, AC-23B kW		7,5	10	12	16	20	30	40	30	37	45	55	75	90	110	132	
AC-3 kW		5,5	6,5	7,5	11	15	22	30	22	30	37	45	55	55	75	55	
Thermal Current I <sub>u</sub> /I <sub>th</sub> A		16	20	25	32	40	63	80	80	100	125	160	200	250	315	315	
Version	Four Hole Panel Mounting	EAN-Code	Version	Base Mounting	EAN-Code												
Protection		9004257	Protection		9004257												
IP 66 <sup>1</sup>		KH16 T304 E 07069 5 KH16B T304 E 07070 1 KH20 T304 E 07071 8 KH20B T304 E 07072 5 KH25 T304 E 07073 2 KH25B T304 E 07074 9 KH32 T304 E 06544 8 KH40 T304 E 06545 5 KH63 T304 E 07536 2 KH80 T304 E 07537 9 KG80C T304 E 00877 3 KG100 T304 E 00878 0 KG100C T304 E 00879 7 KG125 T304 E 00881 0 KG160 T304 E 00882 7 KG210 T304 E 07534 8 KG250 T304 E 00884 1 KG315 T304 E 00885 8 C316 T304 E 00886 5	IP 40		KG160 T304 VE 00903 9 KG210 T304 VE 07535 5 KG250 T304 VE 00905 3 KG315 T304 VE 00906 0 C316 T304 VE 00907 7  and shaft extension  KH16 T304/57 VE 07084 8 KH16B T304/57 VE 07085 5 KH20 T304/57 VE 07086 2 KH20B T304/57 VE 07087 9 KH25 T304/57 VE 07088 6 KH25B T304/57 VE 07089 3 KH32 T304/57 VE 06548 6 KH40 T304/57 VE 06549 3 KH63 T304/57 VE 07538 6 KH80 T304/57 VE 07539 3 KG80C T304/57 VE 00915 2 KG100 T304/57 VE 00916 9 KG100C T304/57 VE 00917 6 KG125 T304/57 VE 00919 0 KG160 T304/57 VE 00920 6 KG210 T304/57 VE 07540 9 KG250 T304/57 VE 00922 0 KG315 T304/57 VE 00923 7 C316 T304/57 VE 00924 4												
						<b>Single Hole Mounting 22 mm</b>	KH16 T304 FT2 07075 6 KH20 T304 FT2 07076 3 KH25 T304 FT2 07077 0										
IP 40		<b>Base Mounting</b>															
		KH16 T304 VE 07078 7 KH16B T304 VE 07079 4 KH20 T304 VE 07080 0 KH20B T304 VE 07081 7 KH25 T304 VE 07082 4 KH25B T304 VE 07083 1 KH32 T304 VE 06546 2 KH40 T304 VE 06547 9 KH63 T304 VE 07541 6 KH80 T304 VE 07542 3 KG80C T304 VE 00898 8 KG100 T304 VE 00899 5 KG100C T304 VE 00900 8 KG125 T304 VE 00902 2															

<sup>1</sup>C316 protection IP 40. Higher protection available on request.

## Switch Disconnectors — | 6 pole, Types of Mounting

## Switch Disconnectors — | 8 pole, Types of Mounting







Technical Data		KG10A KG10B    KG20B KH16    KH20    KH25    KG32B    KG41B    KG64B    KG80 KH16B    KH20B    KH25B    KH32    KH40    KH63    KH80    KG100 KG100C    KG125    KG160    C316											
Ratings													
3 x 380 V/440 V													
AC-23A, AC-23B	kW	7,5	5,5/10 <sup>2</sup>	7,5/12 <sup>2</sup>	11/16 <sup>2</sup>	15/20 <sup>2</sup>	22/30 <sup>2</sup>	30/40	37	45	55	132	
AC-3	kW	5,5	3,7/6,5 <sup>2</sup>	5,5/7,5 <sup>2</sup>	7,5/11 <sup>2</sup>	11/15 <sup>2</sup>	18,5/22 <sup>2</sup>	22/30	30	37	45	55	
Thermal Current I <sub>U</sub> /I <sub>th</sub>	A	16	20	25	32	40	63	80	100	125	160	315	
Version Protection	Four Hole Panel Mounting	EAN- Code 9004257	Version Protection	Four Hole Panel Mounting	EAN- Code 9004257								
IP 66 <sup>1</sup>  	KG10A    T306 E KG10B    T306 E KG20B    T306 E KG32B    T306 E KG41B    T306 E KG64B    T306 E KG80      T306 E KG80C    T306 E KG100    T306 E KG100C   T306 E KG125    T306 E KG160    T306 E C316     T306 E	01296 1 01297 8 00925 1 00926 8 00927 5 00928 2 00929 9 00930 5 00931 2 00932 9 03683 7 03685 1 00935 0	IP 66  	KH16      T308 E KH16B    T308 E KH20      T308 E KH20B    T308 E KH25      T308 E KH25B    T308 E KH32      T308 E KH40      T308 E	09323 6 09324 3 09325 0 09326 7 09327 4 09328 1 09329 8 09330 4								
	IP 40    	<b>Base Mounting</b>											
		KG10A    T306 VE KG10B    T306 VE KG20B    T306 VE KG32B    T306 VE KG41B    T306 VE KG64B    T306 VE KG80      T306 VE KG80C    T306 VE KG100    T306 VE KG100C   T306 VE KG125    T306 VE KG160    T306 VE C316     T306 VE		01298 5 01299 2 00936 7 00937 4 00938 1 00939 8 00940 4 00941 1 00942 8 00943 5 03684 4 03686 8 00946 6									
		and shaft extension											
		KG10A    T306/57 VE KG10B    T306/57 VE KG20B    T306/57 VE KG32B    T306/57 VE KG41B    T306/57 VE KG64B    T306/57 VE KG80      T306/57 VE KG80C    T306/57 VE KG100    T306/57 VE KG100C   T306/57 VE KG125    T306/57 VE KG160    T306/57 VE C316     T306/57 VE		01300 5 01301 2 00947 3 00948 0 00949 7 00950 3 00951 0 00952 7 00953 4 00954 1 03687 5 03688 2 00957 2									

[< back to table of contents >](#)

<sup>1</sup>C80, C125 and C316 protection IP 40. Higher protection available on request. <sup>2</sup>The values after the slash are valid for KH switches.

**Switch Disconnectors 1 – 0 – 2**  
**Double-throw Switches 3 pole,**  
**Types of Mounting**

**Switch Disconnectors 1 – 0 – 2**  
**Double-throw Switches 2 and 4 pole,**  
**Types of Mounting**















Technical Data											
		KH16		KH20		KH25		KH32		C316	
		KH16B		KH20B		KH25B		KH32		C316	
		KH16B		KH20B		KH25B		KH32		C316	
Ratings		7,5		10		7,5/12 <sup>2</sup>		11/16 <sup>2</sup>		132	
3 x 380 V/440 V		7,5		10		7,5/12 <sup>2</sup>		11/16 <sup>2</sup>		132	
AC-23A, AC-23B		7,5		10		7,5/12 <sup>2</sup>		11/16 <sup>2</sup>		132	
AC-3		5,5		6,5		5,5/7,5 <sup>2</sup>		7,5/11 <sup>2</sup>		55	
Thermal Current I <sub>U</sub> /I <sub>th</sub>		5,5		6,5		5,5/7,5 <sup>2</sup>		7,5/11 <sup>2</sup>		55	
		16		20		25		32		315	
Version		Four Hole Panel Mounting		EAN-Code		Ausführung		Four Hole Panel Mounting		EAN-Code	
Protection		Panel Mounting		Code		Schutzart		Panel Mounting		Code	
		Panel Mounting		9004257				Panel Mounting		9004257	
IP 66 <sup>1</sup>		KG20A T903 E		00958 9		IP 66		<b>2 pole</b>			
		KG20B T903 E		00959 6				KH16 T902 E		09333 5	
		KG32A T903 E		00960 2				KH16B T902 E		09334 2	
		KG32B T903 E		00961 9				KH20 T902 E		09335 9	
		KG41B T903 E		00962 6				KH20B T902 E		09336 6	
		KG64B T903 E		00963 3				KH25 T902 E		09337 3	
		KG80 T903 E		00964 0				KH25B T902 E		09338 0	
		KG80C T903 E		00965 7				KH32 T902 E		09339 7	
		KG100 T903 E		00966 4				KH40 T902 E		09340 3	
		KG100C T903 E		00967 1				KH63 T902 E		09341 0	
		KG125 T903 E		03689 9				KH80 T902 E		09342 7	
		KG160 T903 E		03691 2							
		C316 T903 E		00970 1							
IP 40		<b>Base Mounting</b>				IP 66		<b>4 pole</b>			
		KG20B T903 VE		00971 8				KH16 T904 E		09343 4	
		KG32B T903 VE		00972 5				KH16B T904 E		09344 1	
		KG41B T903 VE		00973 2				KH20 T904 E		09345 8	
		KG64B T903 VE		00974 9				KH20B T904 E		09346 5	
		KG80 T903 VE		00975 6				KH25 T904 E		09347 2	
		KG80C T903 VE		00976 3				KH25B T904 E		09348 9	
		KG100 T903 VE		00977 0				KH32 T904 E		09349 6	
		KG100C T903 VE		00978 7				KH40 T904 E		09350 2	
		KG125 T903 VE		03690 5							
		KG160 T903 VE		03692 9							
		C316 T903 VE		00981 7							
		and shaft extension									
		KG20B T903/57 VE		00982 4							
		KG32B T903/57 VE		00983 1							
		KG41B T903/57 VE		00984 8							
		KG64B T903/57 VE		00985 5							
		KG80 T903/57 VE		00986 2							
		KG80C T903/57 VE		00987 9							
		KG100 T903/57 VE		00988 6							
		KG100C T903/57 VE		00989 3							
		KG125 T903/57 VE		03693 6							
		KG160 T903/57 VE		03694 3							
		C316 T903/57 VE		00992 3							
IP 40		<b>Base Mounting for Track</b>									
		KG20A T903 VE2		06488 5							
		KG32A T903 VE2K-		06489 2							
		G41B T903 VE2		06490 8							
		KG64B T903 VE2		06491 5							
		KG80 T903 VE2		06492 2							
		KG100 T903 VE2		06493 9							

[< back to table of contents >](#)

<sup>1</sup>C80, C125 and C316 protection IP 40. Higher protection available on request. <sup>2</sup>The values after the slash are valid for KH switches.

# Switch Disconnectors



## 3, 4, and 6 pole, in Plastic Enclosure (conduit entries for metric threads)

Technical Data																
		KG20		KG32		KG41		KG64								
		KG10		KG20B		KG32B		KG41B		KG64B		KG80				
		KH16	KH20	KH25	KH32	KH40	KH63	KH80	KG100	KG125	KG160	KG250	KG315	C316		
Ratings																
3 x 380 V/440 V																
AC-23A, AC-23B		kW	7,5	5,5/10 <sup>4</sup>	7,5/12 <sup>4</sup>	11/16 <sup>4</sup>	15/20 <sup>4</sup>	22/30 <sup>4</sup>	30/40 <sup>4</sup>	37	45	55	90	110	132	
AC-3		kW	5,5	3,7/6,5 <sup>4</sup>	5,5/7,5 <sup>4</sup>	7,5/11 <sup>4</sup>	11/15 <sup>4</sup>	18,5/22 <sup>4</sup>	22/30 <sup>4</sup>	30	37	45	55	75	55	
Thermal Current I <sub>the</sub>		A	16	20	25	32	40	63	80	100	125	160	250	315	315 <sup>2</sup> /275 <sup>3</sup>	
Version	3 pole	EAN-Code		Version	4 pole	EAN-Code										
Protection IP 66/67		9004257		Protection IP 66/67		9004257										
	KG10 T303 KS51 KG20 T303 KS51	07283 5 07284 2			KG125 T304/60 STM KG160 T304/60 STM KG250 T304/61 STM KG315 T304/61 STM <sup>5</sup> C316 T304/62 STM <sup>5</sup>	07309 2 07310 8 07311 5 07312 2 07313 9										
	KG20 T303 KL51 KG32 T303 KL51 KG41 T303 KL11 KG64 T303 KL11 KG80 T303 KL71 KG100 T303 KL71	07285 9 07286 6 07287 3 07288 0 07289 7 07290 3			<b>Oversized Wiring Space</b>											
	KG125 T303/59 STM <sup>1</sup> KG160 T303/59 STM <sup>1</sup> KG250 T303/61 STM KG315 T303/61 STM <sup>5</sup> C316 T303/62 STM <sup>5</sup>	07291 0 07292 7 07293 4 07294 1 07295 8			<b>6 pole</b>											
	<b>Oversized Wiring Space</b>				KG10 T306 KS51 KG20B T306 KL11 KG32B T306 KL11 KG41B T306 KL71 KG64B T306 KL71	07319 1 07320 7 07321 4 07322 1 07323 8										
	KG125 T303/61 STM KG160 T303/61 STM KG250 T303/63 STM <sup>5</sup> KG315 T303/63 STM <sup>5</sup> C316 T303/63 STM <sup>5</sup>	07296 5 07297 2 07298 9 07299 6 07300 9			KG80 T306/59 STM <sup>1</sup> KG100 T306/59 STM <sup>1</sup> KG125 T306/59 STM <sup>1</sup> KG160 T306/59 STM <sup>1</sup> C316 T306/63 STM <sup>5</sup>	07324 5 07325 2 07326 9 07327 6 07328 3										
	<b>4 pole</b>				<b>Oversized Wiring Space</b>											
	KH16 T304 KS51 KH20 T304 KS11	08763 1 08764 8			KG125 T306/61 STM KG160 T306/61 STM C316 T306/64 STM <sup>5</sup>	07329 0 07330 6 07331 3										
	KH25 T304 KL11 KH32 T304 KL11 KH40 T304 KL11 KH63 T304 KL71 KH80 T304 KL71 KG100 T304 KL71	08765 5 08766 2 08767 9 08863 8 08864 5 07308 5														

[< back to table of contents >](#)

<sup>1</sup>Protection IP 65. <sup>2</sup>For switches 3 and 4 pole. <sup>3</sup>For switches 6 pole. <sup>4</sup>The values after the slash are valid for KH switches. <sup>5</sup>Switches with cable glands.

## Lateral mounted Auxiliary Contacts

Version	For Switch Type	For Front Mounting	EAN-Code 9004257	For Base Mounting	EAN-Code 9004257
Lateral mounted auxiliary contacts with 1 NO + 1 NC 	KG20-KG32B, KH16-KH25B	K0 H010/A11-E	06473 1	K0 H010/A11-VE	06474 8
	KH32, KH40, KH63, KH80	K1 H010/11A-E	06542 4	K1 H010/11A-VE	06543 1
	KG41-KG64B	K1 H010/A11-E	06475 5	K1 H010/A11-VE	06476 2
	KG80-KG100C	K2 H010/A11-E	06477 9	K2 H010/A11-VE	06478 6
Lateral mounted auxiliary contacts with 2 NO + 1 NC 	KG125, KG160	K3A H010/A21-E	06479 3	K3A H010/A21-VE	06480 9
	KG210, KG250, KG315	K3 H010/A21-E	06481 6	K3 H010/A21-VE	06482 3

## Protective Covers

Version	For Switch Type		EAN-Code 9004257		EAN-Code 9004257
	KG10A, KG10B	<b>2 pole</b>	01574 0	<b>3 and 4 pole</b>	01575 7
		S0 M160/A12		S0 M160/A12 K2	
	KG20A, KG20B KG32A, KG32B	<b>3 pole</b>	01576 4	<b>4 pole</b>	01579 5
		K0 M160/3		K0 M160/4	
	KG41, KG41B KG64, KG64B	K1 M160/3	01577 1	K1 M160/4	01580 1
		K2 M160/3	01578 8	K2 M160/4	01581 8
	KG80, KG80C KG100, KG100C	K3 M160/32	01582 5	K3 M160/42	01583 2
		K3 M160/30	06486 1	K3 M160/40	06487 8
	KG125, KG160	<b>For Front Mounting</b>		<b>For Base Mounting</b>	
		KH32, KH40 KH63, KH80	K1 M160/45-E	09198 0	K1 M160/45-VE
K1 M160/44-E	08905 5		K1 M160/44-VE	08906 2	

[< back to table of contents >](#)

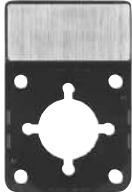
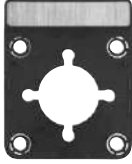

## Add-on Escutcheon Plates

Version Escutcheon Plate frame Black	Description	Escutcheon Plate Size  in mm	Escutcheon Plate Backing Brushed Alu	EAN- Code 9004257	Escutcheon Plate Backing Yellow	EAN- Code 9004257	
Higher Inscription field  	HAUPTSCHALTER	48 x 48 64 x 64 88 x 88 130 x 130	S0 F822/A1B - PRA S1 F822/A1B - PRA S2 F822/A1B - PRA S3 F822/A1B - PRA	01538 2 01539 9 01540 5 01541 2	S0 F822/E1B - PRA S1 F822/E1B - PRA S2 F822/E1B - PRA S3 F822/E1B - PRA	01542 9 01543 6 01544 3 01545 0	
	HAUPTSCHALTER NUR IN 0-STELLUNG ÖFFNEN	48 x 48 64 x 64 88 x 88 130 x 130	S0 F832/A1B - PRA S1 F832/A1B - PRA S2 F832/A1B - PRA S3 F832/A1B - PRA	01546 7 01547 4 01548 1 01549 8	S0 F832/E1B - PRA S1 F832/E1B - PRA S2 F832/E1B - PRA S3 F832/E1B - PRA	01550 4 01551 1 01552 8 01553 5	
	HAUPTSCHALTER MAIN SWITCH	48 x 48 64 x 64 88 x 88 130 x 130	S0 F836/A1B - PRA S1 F836/A1B - PRA S2 F836/A1B - PRA S3 F836/A1B - PRA	06335 2 06336 9 06337 6 06338 3	S0 F836/E1B - PRA S1 F836/E1B - PRA S2 F836/E1B - PRA S3 F836/E1B - PRA	06339 0 06340 6 06341 3 06342 0	
	MAIN SWITCH	48 x 48 64 x 64 88 x 88 130 x 130	S0 F824/A1B - PRA S1 F824/A1B - PRA S2 F824/A1B - PRA S3 F824/A1B - PRA	01554 2 01555 9 01556 6 01557 3	S0 F824/E1B - PRA S1 F824/E1B - PRA S2 F824/E1B - PRA S3 F824/E1B - PRA	01558 0 01559 7 01560 3 01561 0	
	INTERRUPTEUR GENERAL	48 x 48 64 x 64 88 x 88 130 x 130	S0 F828/A1B - PRA S1 F828/A1B - PRA S2 F828/A1B - PRA S3 F828/A1B - PRA	01562 7 01563 4 01564 1 01565 8	S0 F828/E1B - PRA S1 F828/E1B - PRA S2 F828/E1B - PRA S3 F828/E1B - PRA	01566 5 01567 2 01568 9 01569 6	
	Lower Inscription field  	HAUPTSCHALTER	48 x 48 64 x 64	S0 F822/A1B - PRC S1 F822/A1B - PRC	00549 9 00552 9	S0 F822/E1B - PRC S1 F822/E1B - PRC	00555 0 01588 7
		HAUPTSCHALTER NUR IN 0-STELLUNG ÖFFNEN	48 x 48 64 x 64	S0 F832/A1B - PRC S1 F832/A1B - PRC	01570 2 01571 9	S0 F832/E1B - PRC S1 F832/E1B - PRC	01572 6 01573 3
		HAUPTSCHALTER MAIN SWITCH	48 x 48 64 x 64	S0 F836/A1B - PRC S1 F836/A1B - PRC	06343 7 06344 4	S0 F836/E1B - PRC S1 F836/E1B - PRC	06345 1 06346 8
		MAIN SWITCH	48 x 48 64 x 64	S0 F824/A1B - PRC S1 F824/A1B - PRC	00550 5 00553 6	S0 F824/E1B - PRC S1 F824/E1B - PRC	00556 7 01589 4
		INTERRUPTEUR GENERAL	48 x 48 64 x 64	S0 F828/A1B - PRC S1 F828/A1B - PRC	00551 2 00554 3	S0 F828/E1B - PRC S1 F828/E1B - PRC	00557 4 01590 0

< back to table of contents >

## Terminals for Control Circuit

Version	For Switch Type		EAN-Code 9004257	Max. Permissible Wire Gage Single-core or stranded wire	Flexible wire
	KG41-KG64B	K1B D220 KS	08907 9	2,5 mm <sup>2</sup> AWG12	2,5 mm <sup>2</sup> AWG14
	KG80-KG100C	K2B D520 KSA	06483 0	2,5 mm <sup>2</sup> AWG12	2,5 mm <sup>2</sup> AWG14
	KG125, KG160	K3A D720 KS	06484 7	4 mm <sup>2</sup> AWG10	4 mm <sup>2</sup> AWG12
	KG210, KG250, KG315, C316	K3B D520 KS	06485 4	4 mm <sup>2</sup> AWG10	4 mm <sup>2</sup> AWG12

## Unlock Insert

Version	Unlock insert for the M700		EAN-Code 9004257	
	To open the door in ON position. (After the locking has been made inactive, it is necessary to take effective precautions against an opening of the door by unauthorized persons.)	S1D M700 29	07090 9	

## Mounting Key

Version	For Switches with Single Hole Mounting		EAN-Code 9004257	
	Mounting key for locking nut	S00 T170 09	08726 6	

## Connection Diagrams

(KG and C switches)

### 3 pole

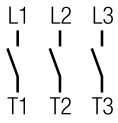

### 3 pole + 1 NO for KG switches

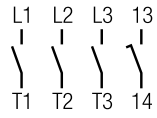

### 3 pole + 1 NO for C switches

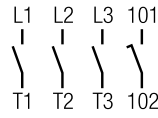

### 3 pole + 1 NO, 1 NC for KG switches

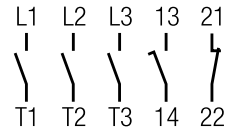

### 3 pole + 1 NO, 1 NC for C switches

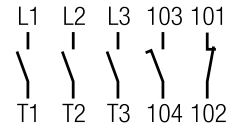

### 3 pole + PE, N

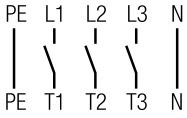

### 4 pole

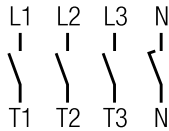

### 4 pole + 1 NO, 1 NC for KG switches

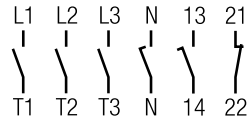

### 4 pole + 1 NO, 1 NC for C switches

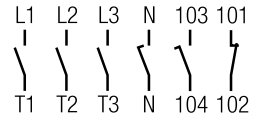

### 6 pole

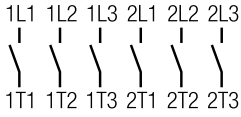

### 6 pole + 1 NO, 1 NC for KG switches

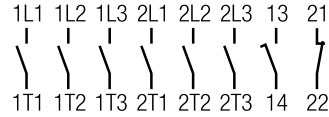

### 6 pole + 1 NO, 1 NC for C switches

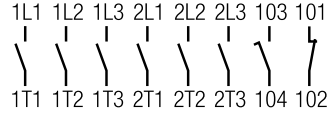

### 3 pole (Double-throw switches)

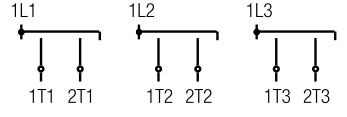

## Connection Diagrams

(KH switches)

### 3 pole + PE

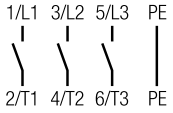

### 3 pole + N

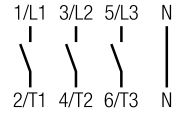

### 4 pole

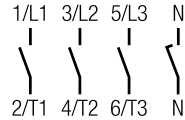

### 8 pole

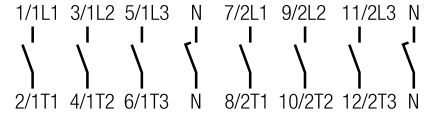

### 2 pole (Double-throw switches)

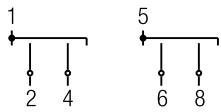

### 4 pole (Double-throw switches)

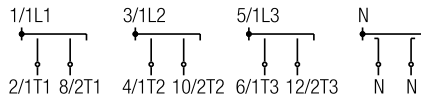

## Switches for Panel Mounting Two or Four Hole Panel Mounting

Dimensions mm inch

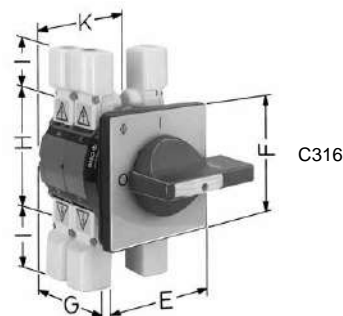
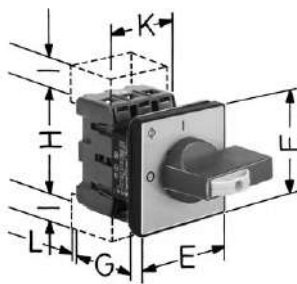
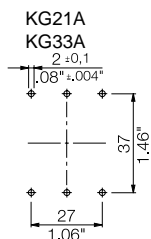
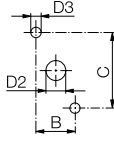
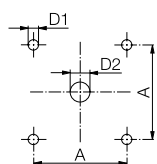

	A	B <sup>2</sup>	C <sup>2</sup>	D1	D2	D3	E/F	Pole					H	I	Pole					L		
								2	3, 4	3 + 1	3 + PE, N	6 <sup>1</sup>			2, 3, 3 + 1	3 + PE, N	4 <sup>1</sup> 3 + PE 3 + N	6 <sup>1</sup>	8 <sup>1</sup>			
KG10A	36 1.42	12,2 .48	30 1.18	5 .20	11-15 .43-.59	3,5 .14	48 1.89	38,7 1.52	48,2 1.90	48,2 1.90		58 2.28	50 1.97	7,5 .30	48 1.89		48 1.89					
KG10B	48 1.89	12,2 .48	30 1.18	5 .20	11-15 .43-.59	3,5 .14	64 2.52	45,7 1.80	55,2 2.17	55,2 2.17		67 2.64	50 1.97	7,5 .30	48 1.89		48 1.89					
KG20A, KG32A, KG21A, KG33A	36 1.42	12,2 .48	30 1.18	5 .20	10 .39	3,5 .14	48 1.89		53,8 <sup>3</sup> 2.12	62,8 2.47	53,8 2.12	61,3 2.42	54 2.13	20 .79	42 1.65	69 2.72	56 2.21					6 .24
KG20B, KG32B	48 1.89	12,2 .48	30 1.18	5 .20	10 .39	3,5 .14	64 2.52		53,8 2.12	62,8 2.47	53,8 2.12	61,3 2.42	54 2.13	20 .79	42 1.65	69 2.72	56 2.21	84 3.31				6 .24
KG41, KG64	36 1.42			5 .20	10 .39		48 1.89		60,5 2.38		60,5 2.38	61,3 2.42	64 2.52	17 .67	50 1.97	82 3.23	66 2.60					5,5 .22
KG41B, KG64B	48 1.89	12,2 .48	30 1.18	5 .20	10 .39	3,5 .14	64 2.52		60,5 2.38	73 2.87	60,5 2.38	66,5 2.62	64 2.52	17 .67	50 1.97	82 3.23	66 2.60	100 3.94				5,5 .22
		14 .55	37 1.46			4,5 .18																
KG41B T.3/81 E, KG64B T.3/81 E	68 2.68			6 .24	10 .39		88 3.46		61 2.40			64 2.52	17 .67	50 1.97								5,5 .22
KG80, KG100	48 1.89	14 .55	37 1.46	5 .20	10 .39	4,5 .18	64 2.52		70,6 2.78	80,6 3.17	70,6 2.78	81,8 3.22	80 3.15	26 1.02	70 2.76	114 4.49	92 3.62	140 5.51				5,5 .22
KG80C, KG100C	68 2.68	14 .55	37 1.46	6 .24	10 .39	4,5 .18	88 3.46		70,6 2.78	80,6 3.17	70,6 2.78	81,8 3.22	80 3.15	26 1.02	70 2.76	114 4.49	92 3.62	140 5.51				5,5 .22
KG125, KG160	68 2.68			6 .24	13 .51		88 3.46		96 3.78	117 4.61	96 3.78	98 3.86	108 4.25	22,2 .87	112 4.41	188 7.40	150 5.91	224 8.82				
KG210, KG250, KG315	68 2.68			6 .24	13 .51		88 3.46		103 4.06	124 4.88	103 4.06	126 4.96	25 0.98	145 5.71	250 9.84	197,5 7.78						6 .24
KH16, KH20, KH25	36 1.42	12,2 .48	30 1.18	5 .20	10-15 .39	3,5 .14	48 1.89		49 1.93			56 2.20										120,1 4.73
KH16B, KH20B, KH25B	48 1.89	12,2 .48	30 1.18	5 .20	10-15 .39	3,5 .14	64 2.52		49 1.93			56 2.20										120,1 4.73
KH32, KH40	48 1.89	12,2 .48	30 1.18	5 .20	10-15 .39-.59	3,5 .14	64 2.52		54 2.13			62 2.44	14 .55									140,1 5.52
KH63, KH80	48 1.89	14 .55	37 1.46	5 .20	10-15 .39-.59	4,5 .18	64 2.52		62 2.44			90 3.54	23,5 .93									172,1 6.78
C316	104 4.09			7 .28	16 .63		130 5.12		117,2 4.61	137,2 5.40		155,8 6.13	150 5.91	46 1.81	128 5.04		128 5.04	128 5.04				

<sup>1</sup>Also valid for double-throw switches. <sup>2</sup>Only for main switches and main switches with emergency function. <sup>3</sup>KG21A and KG33A G = 56,1 mm/2.21 inch.

## Single Hole Mounting 22 mm

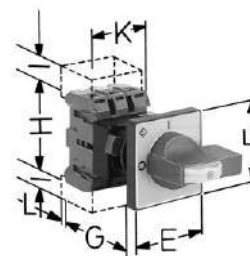
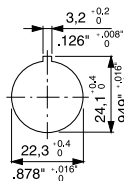

	E/F	E/F	E/F	Pole				H	I	Pole				L
				2	3, 4	3 + 1	3 + PE, N			2, 3, 3 + 1	3 + PE, N	4	K	
KG10A	49 1.93	48 1.89		56,6 2.23	66,1 2.60	66,1 2.60		50 1.97	7,5 .30	48 1.89		48 1.89		
KG10B		64 2.52	64 2.52	56,6 2.23	66,1 2.60	66,1 2.60		50 1.97	7,5 .30	48 1.89		48 1.89		
KG20A, KG32A	49 1.93	48 1.89			68,3 2.69	77,3 3.04	68,3 2.69	54 2.13	20 .79	42 1.65	69 2.72	56 2.20	6 .24	
KG20B, KG32B		64 2.52	64 2.52		68,3 2.69	77,3 3.04	68,3 2.69	54 2.13	20 .79	42 1.65	69 2.72	56 2.20	6 .24	
KH16, KH20, KH25 FT2	49 1.93	48 1.89			63,5 2.50			56 2.20				60 2.36		
KH16, KH20, KH25 FH3		64 2.52	64 2.52		63,5 2.50			56 2.20				60 2.36		
KH32, KH40		64 2.52	64 2.52		68,7 2.70			62 2.44	14 .55			70 2.76		
KH63, KH80		64 2.52	64 2.52		77,1 3.04			90 3.54	23,5 .93			86 3.39		

< back to table of contents >

# Switches for Base Mounting

# Dimensions mm inch

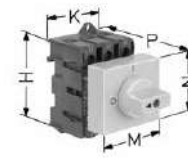
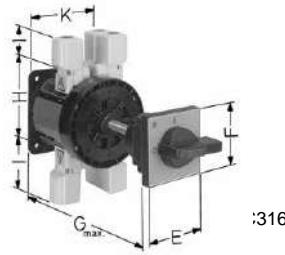
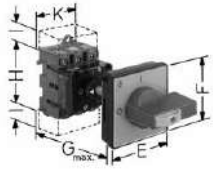

### Switch Disconnectors

### Main Switches and Main Switches with Emergency Function

	With shaft extension				With single hole mounting without centering device														
	E/F	G	G	G	E/F <sup>2</sup>	G	Pole 2		Pole 3 + 1		Pole 3,3+1		Pole 3 + PE, N		Pole 4		Pole 6 <sup>1</sup>		
		3, 4	6 <sup>1</sup>	3, 4, 6 <sup>1</sup>			2	3, 4, 3 + PE, N <sup>3</sup>	3 + 1	H	I	K	K	K	K	M	N	P	P
KG10A	48	61,2	70,7	190	48	190	151,2	160,7	160,7	50		48		48	48	52	44,7	64,3	
KG10B	64	85,2	94,7	190	64	190	160,2	169,7	169,7	50		48		48	48				
KG20A, KG32A	48	62		190	48	190		166,5	175,5	54	20	42	69	55,5	84	43,3	44,2	61	69
KG20B, KG32B	64	63,5	71	190	64	190		166,5	175,5	54	20	42	69	55,5	84	1,70	1,74	2,40	2,72
KG41, KG64	48	73		190 <sup>5</sup>	48	190 <sup>5</sup>		183,5	193,5	64	17	50	82	66		52	44,4	61,5	
KG41B, KG64B	64	74,5	80,5	190 <sup>5</sup>	64	190 <sup>5</sup>		183,5	193,5	64	17	50	82	66	100				67,5
KG80	64	81,5	92,7	380	64	380		187,5	197,5	80	26	70	114	92	140	70	45	70	
KG80C	88	81,5	92,7	380	88	380										2,76	1,77	2,76	
KG100	64	81,5	92,7	450	64	450		187,5	197,5	80	26	70	114	92	140	70	45	70	
KG100C	88	81,5	92,7	450	88	450										2,76	1,77	2,76	
KG125, KG160	88	107	109	450	88	450				108	22,2	112	188	150	224				
KG210, KG250, KG315	88	114		550	88	550				126	25	145	250	197,5					
KH16, KH20, KH25	48	59		190	48	190		163,5		56				60					
KH16B, KH20B, KH25B	64	60,5		190	64	190		163,5		56				60					
KH32, KH40	64	79		190	64	190		178		62	14			70					
KH63, KH80	64	85		330 <sup>6</sup>	64	330 <sup>6</sup>		187,5		90	23,5			86					
C316	130	148	186,5	550	88	550				150	46	128		128	128				

[< back to table of contents >](#)

	Bottom Plate					Front Plate					D2 <sup>4</sup>	D2 <sup>4</sup>	D3 <sup>5</sup>	
	A	B	C	C1	D1	E <sup>4</sup>	D3 <sup>5</sup>	D2	D2 <sup>4</sup>	D3 <sup>5</sup>				
KG10A						36	5	8-15	19-22					
KG10B						1.42	.20	.32-.59	.75-.87					
KG20A, KG32A	22	60			4,1	36	5	8-15	19-22					
KG20B, KG32B	.87	2.36			.16	1.42	.20	.32-.59	.75-.87					
KG41, KG64	25	70			4,1	36	5	8-15	19-22					
KG41B, KG64B	.98	2.76			.16	1.42	.20	.32-.59	.75-.87					
KG80, KG100	25	90	47,5	22,5	5,2	48	5	10-15	19-22					
KG80C, KG100C	.98	3.54	1.87	.89	.21	1.89	.20	.39-.59	.75-.87					
KG125, KG160	36	120			6,4	68	6	13-17	26-30					
KG210, KG250, KG315	44	142			6,4	68	6	13-17	26-30					
KH16, KH20, KH25	22	60			4,2	36	5	8-15	19-22					
KH16B, KH20B, KH25B	.86	2.36			.17	1.42	.20	.32-.59	.75-.87					
KH32, KH40	22	60			4,2	48	5	10-15	19-22					
KH63, KH80	.98	2.76			.16	1.89	.20	.39-.59	.75-.87					
C316	104	104			7	104	7	15,5-20	.61-.79					

Bottom Plate

Front Plate

With single hole mounting 22 mm

<sup>4</sup>E = 48    D2 = 39-42    D3 = 5  
 1.89                    1.54-1.69                    .20

For switch type:

KG20B T.../12 VE	KG125 T.../28 VE
KG20B T.../28 VE	KG160 T.../12 VE
KG32B T.../12 VE	KG160 T.../28 VE
KG32B T.../28 VE	KG250 T.../13 VE
KG41B T.../12 VE	KG250 T.../29 VE
KG41B T.../28 VE	KG315 T.../13 VE
KG64B T.../12 VE	KG315 T.../29 VE
KG64B T.../28 VE	KH32 T.../12 VE
KG80 T.../12 VE	KH40 T.../12 VE
KG80 T.../28 VE	KH63 T.../12 VE
KG100 T.../12 VE	KH80 T.../12 VE
KG100 T.../28 VE	C316 T.../13 VE
KG125 T.../12 VE	C316 T.../29 VE

<sup>1</sup> Also valid for double-throw switches. <sup>2</sup> Versions T.../12 VE, T.../13 VE, T.../28 VE, T.../29 VE = 88 mm/3.47 inch. <sup>3</sup> KG10A and KG10B + 9,5 mm/.37 inch. <sup>4</sup> Different dimensions see right table. <sup>5</sup> KG64 and KG64B G = 330 mm/12.99 inch. <sup>6</sup> KH80 G = 380 mm/14.96 inch.

# Switches in Plastic Enclosure

Dimensions mm inch

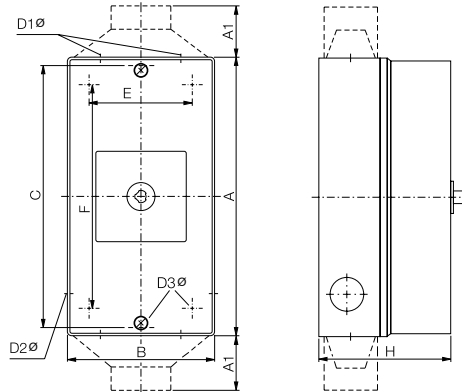

	Pole						A	A1	B	C	D1	D2	D3	E	F	H
	3	3 + 2	4	4 + 2	6	6 + 2										
KG10 T... KS51	x	x	x	x	x	x	120		85	110	2 x 20/25	20	4,2			80
KH16 T... KS51 <sup>2</sup>							4.72	3.35	4.33	2 x .79/.98	.79	.17				3.15
KG10 T... KS51V	x	x	x	x	x	x	120		85	110	2 x 20/25	20	4,2			90
KH16 T... KS51V <sup>2</sup>							4.72	3.35	4.33	2 x .79/.98	.79	.17				3.54
KG20 T... KS51	x						120		86	110	2 x 20/25	20	4,2			80
							4.72	3.35	4.33	2 x .79/.98	.79	.17				3.15
KG20 T... KS51V	x						121		86	110	2 x 20/25	20	4,2			90
							4.72	3.35	4.33	2 x .79/.98	.79	.17				3.54
KG20 <sup>1</sup> , KG32	x	x					160		85	150	2 x 20	20	4,2			80
T... KL51							6.30	3.35	5.91	2 x .79	.79	.17				3.07
KG20 <sup>1</sup> , KG32	x	x					160		85	150	2 x 20	20	4,2			82
T... KL51V							6.30	3.35	5.91	2 x .79	.79	.17				3.23
KH20 T... KS11			x				120		85	110	2 x 20/25	20	4,2			80
							4.72	3.35	4.33	2 x .79/.98	.79	.17				3.15
KH20, KH25			x	x			160		85	150	2 x 25	20	4,2			80
T... KL11							6.30	3.35	5.91	2 x .98	.79	.17				3.07
KH20, KH25			x	x			160		85	150	2 x 25	20	4,2			82
T... KL11V							6.30	3.35	5.91	2 x .98	.79	.17				3.23
KG20B, KG32B					x	x	190		100	178	2 x 25	25	5,6			91
T... KL11							7.48	3.94	7.01	2 x .98	.98	.22				3.58
KG20B, KG32B					x	x	190		100	178	2 x 25	25	5,6			93
T... KL11V							7.48	3.94	7.01	2 x .98	.98	.22				3.66
KG41, KG64 T... KL11	x	x	x	x			190		100	178	2 x 25	25	5,6			91
KH32, KH40 T... KL11 <sup>2</sup>							7.48	3.94	7.01	2 x .98	.98	.22				3.58
KG41, KG64 T... KL11V	x	x	x	x			190		100	178	2 x 25	25	5,6			93
KH32, KH40 T... KL11V <sup>2</sup>							7.48	3.94	7.01	2 x .98	.98	.22				3.66
KG41B, KG64B					x	x	250		145		2 x 40	25	6,5	124	229	107
							9.84	5.71		2 x 1.57	.98	.26	4.88	9.02	4.21	4.21
KG80, KG100	x	x	x	x			250		145		2 x 40	25	6,5	124	229	107
KH63, KH80 <sup>2</sup>							9.84	5.71		2 x 1.57	.98	.26	4.88	9.02	4.21	4.21
KG80, KG100					x	x	300		200		2 x 40/50		M6	172	272	172
KG80C, KG100C							11.81	7.87		2 x 1.57/1.97	3 x .79		6.77	10.71	6.77	6.77
KG125, KG160	x	x					300		200		2 x 40/50		M6	172	272	172
							11.81	7.87		2 x 1.57/1.97	3 x .79		6.77	10.71	6.77	6.77
			x	x			280		280		2 x 50	1 x 20	7	254	254	180
							11.02	11.02		2 x 1.97	1 x .79	.28	10.00	10.00	7.09	7.09
	x <sup>1</sup>	x <sup>1</sup>	x <sup>1</sup>	x <sup>1</sup>			380		280		2 x 63	1 x 20	7	254	354	180
							14.96	11.02		2 x 2.48	1 x .79	.28	10.00	13.94	7.09	7.09
					x	x	300		300		2 x 50	1 x 20	M6	272	272	172
							11.81	11.81		2 x 1.97	1 x .79		10.71	10.71	6.77	6.77
					x <sup>1</sup>	x <sup>1</sup>	400		300		2 x 63	1 x 20	M6	272	372	172
							15.75	11.81		2 x 2.48	1 x .79		10.71	14.65	6.77	6.77
KG250	x	x	x	x			380		280		2 x 63	1 x 20	7	254	354	180
							14.96	11.02		2 x 2.48	1 x .79	.28	10.00	13.94	7.09	7.09
	x <sup>1</sup>	x <sup>1</sup>					560	110	280		1 x 28-60 <sup>3</sup>	2 x 20	7	254	534	180
							22.05	4.33	11.02		1 x 1.10-2.36	2 x .79	.28	10.00	21.02	7.09
			x <sup>1</sup>	x <sup>1</sup>			560	110	380		1 x 28-60 <sup>3</sup>	2 x 20	7	354	534	180
							22.05	4.33	14.96		1 x 1.10-2.36	2 x .79	.28	13.94	21.02	7.09
KG315	x	x	x	x			380	110	280		1 x 28-60 <sup>3</sup>	2 x 20	7	254	354	180
							14.96	4.33	11.02		1 x 1.10-2.36	2 x .79	.28	10.00	13.94	7.09
	x <sup>1</sup>	x <sup>1</sup>					560	110	280		1 x 28-60 <sup>3</sup>	2 x 20	7	254	534	180
							22.05	4.33	11.02		1 x 1.10-2.36	2 x .79	.28	10.00	21.02	7.09
			x <sup>1</sup>	x <sup>1</sup>			560	110	380		1 x 28-60 <sup>3</sup>	2 x 20	7	354	534	180
							22.05	4.33	14.96		1 x 1.10-2.36	2 x .79	.28	13.94	21.02	7.09
C316	x	x	x	x			380	110	280		1 x 28-60 <sup>3</sup>	2 x 20	7	254	354	230
							14.96	4.33	11.02		1 x 1.10-2.36	2 x .79	.28	10.00	13.94	9.06
	x <sup>1</sup>	x <sup>1</sup>	x <sup>1</sup>	x <sup>1</sup>			560	110	280		1 x 28-60 <sup>3</sup>	2 x 20	7	254	534	230
							22.05	4.33	11.02		1 x 1.10-2.36	2 x .79	.28	10.00	21.02	9.06
					x		560	110	280		2 x 28-60 <sup>3</sup>	2 x 20	7	254	534	230
							22.05	4.33	11.02		2 x 1.10-2.36	2 x .79	.28	10.00	21.02	9.06
						x	560	110	280		2 x 28-60 <sup>3</sup>	2 x 20	7	254	534	280
							22.05	4.33	11.02		2 x 1.10-2.36	2 x .79	.28	10.00	21.02	11.02
					x <sup>1</sup>		560	110	380		2 x 28-60 <sup>3</sup>	2 x 20	7	354	534	230
							22.05	4.33	14.96		2 x 1.10-2.36	2 x .79	.28	13.94	21.02	9.06
						x <sup>1</sup>	560	110	380		2 x 28-60 <sup>3</sup>	2 x 20	7	354	534	280
							22.05	4.33	14.96		2 x 1.10-2.36	2 x .79	.28	13.94	21.02	11.02

< back to table of contents >

<sup>1</sup>Oversized wiring space. <sup>2</sup>Pole 4 and 4+2. <sup>3</sup>outside cable diameter

---

# NOTES

[< back to table of contents >](#)

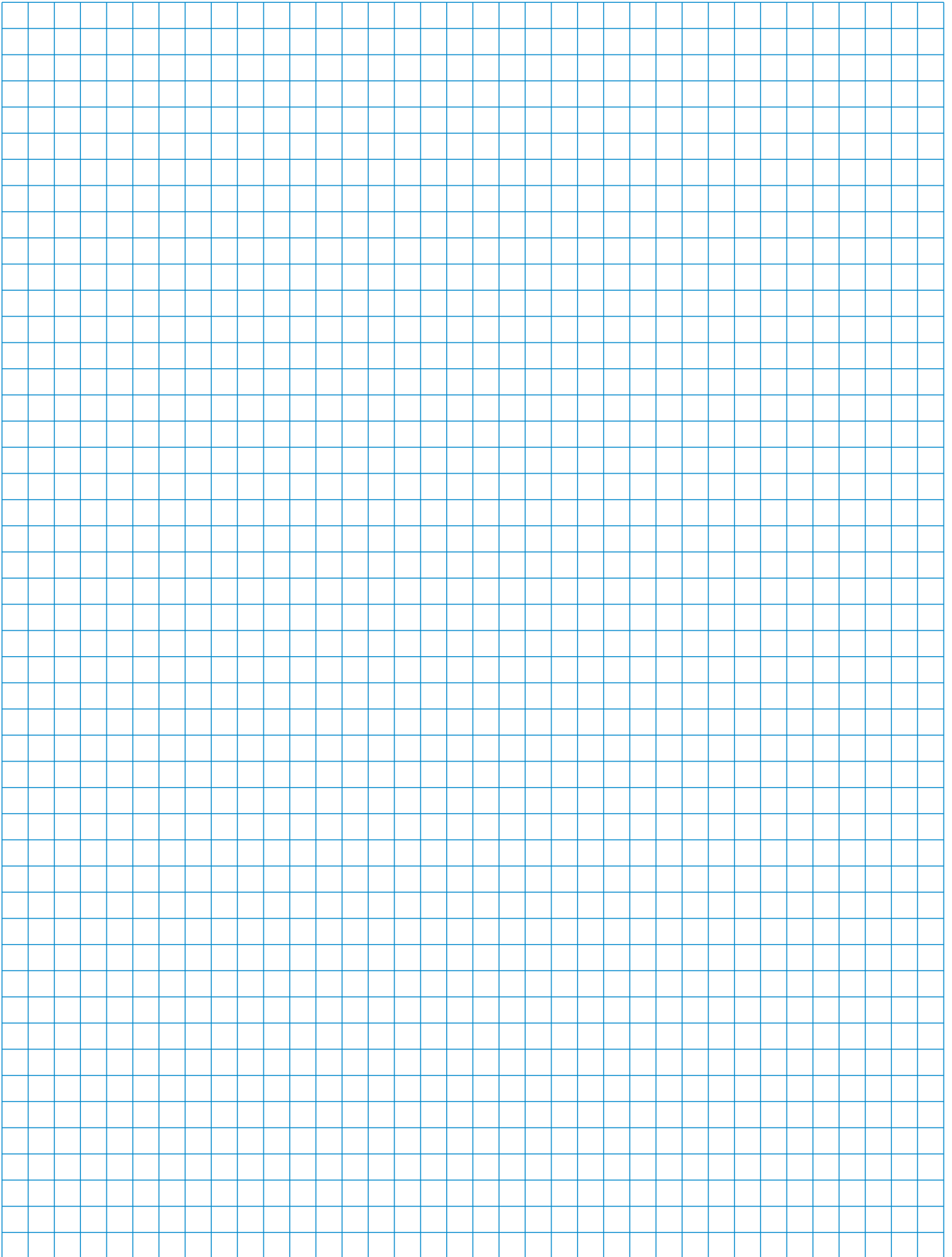

---

# NOTES

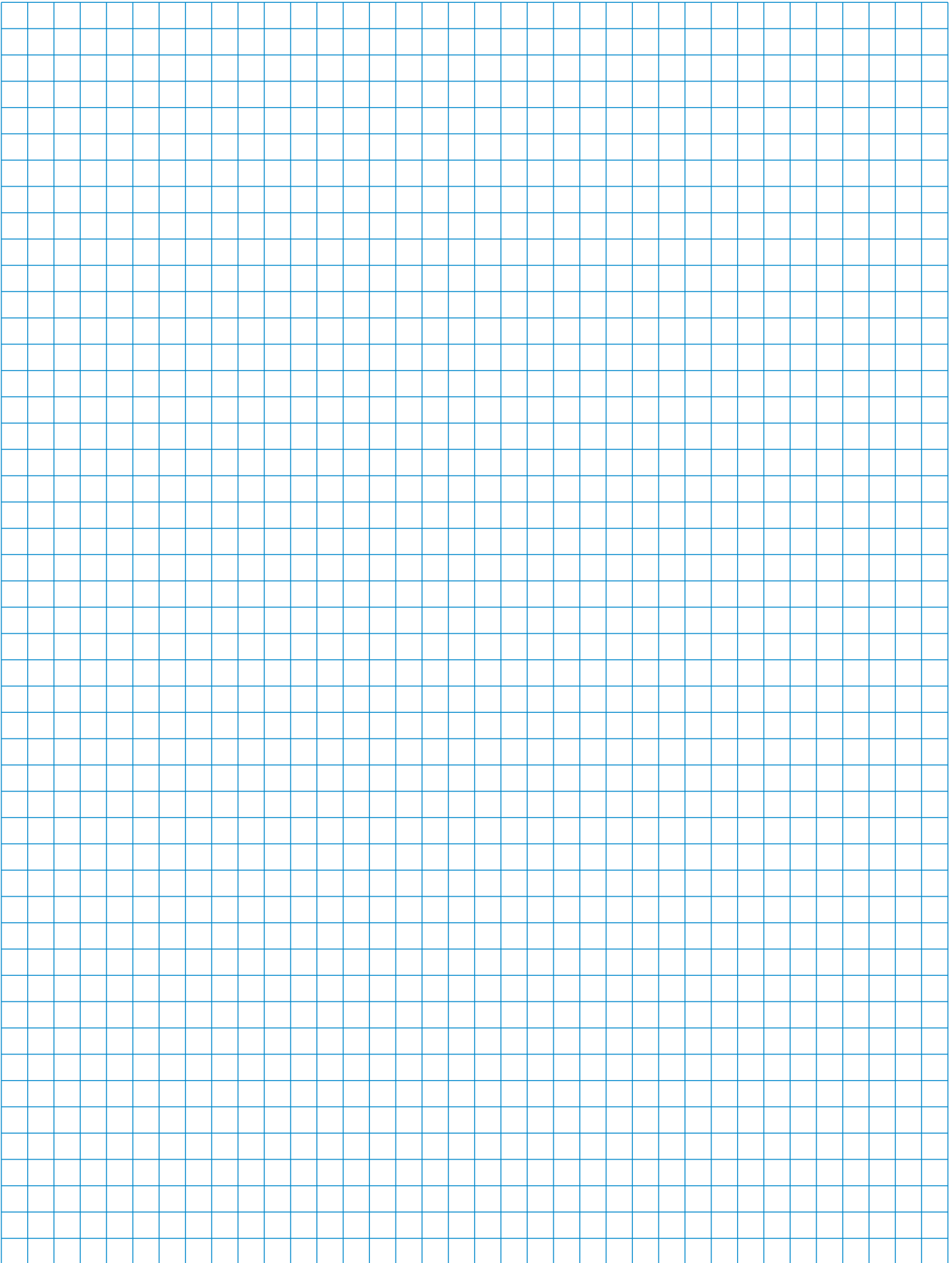

[< back to table of contents >](#)



---

# NOTES

[< back to table of contents >](#)

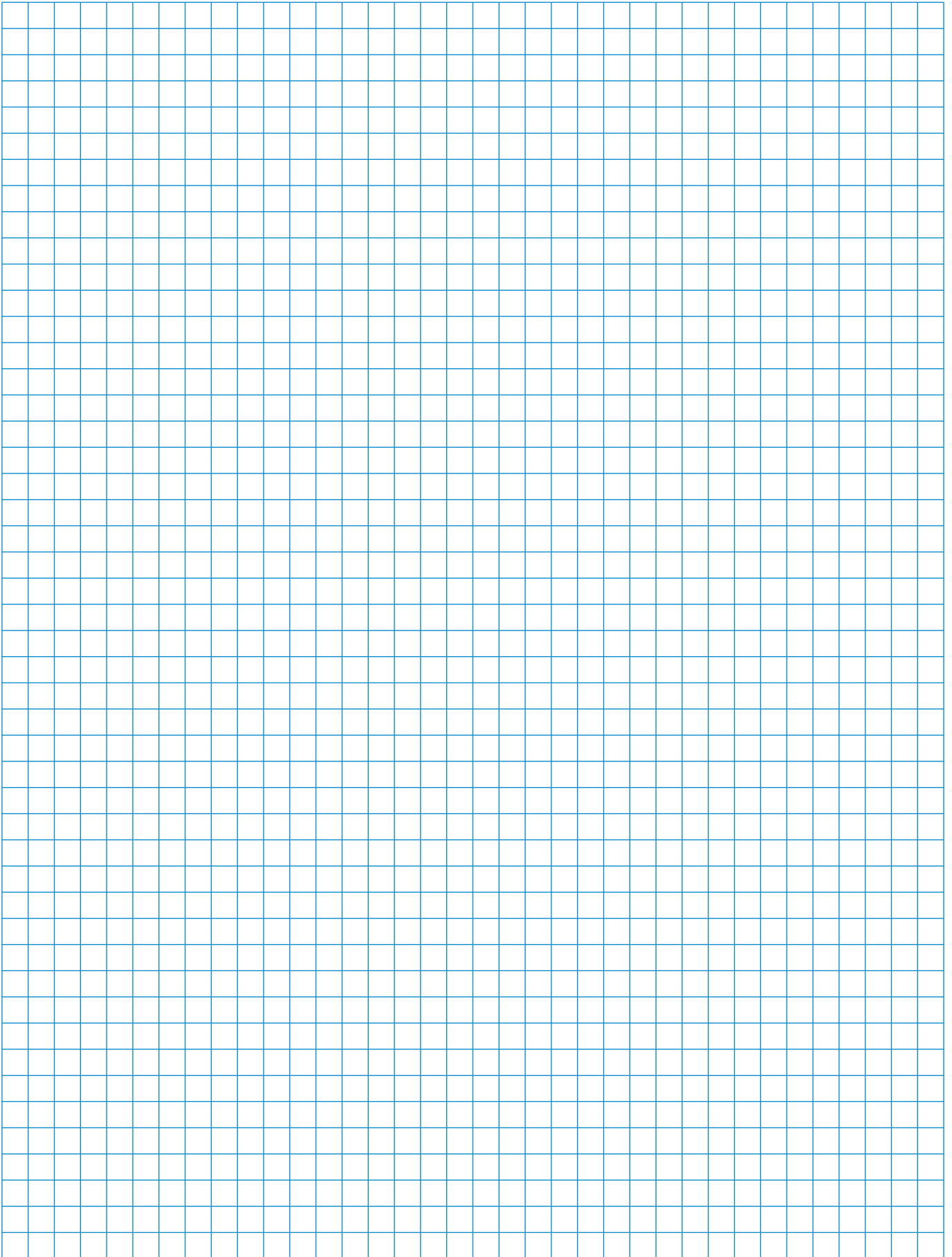

---

# The Range of “Blue Line” Switchgear

Technical literature covering the following products is available on request.

	<b>Catalog Number</b>
<b>Main Switches and Main Switches with Emergency Function 16 A-315 A</b> <b>Maintenance Switches 20 A-315 A</b> <b>Switch Disconnectors 20 A-315 A</b> According to IEC 60947-3, EN 60947-3, VDE 0660 part 107, IEC 60204, EN 60204 and VDE 0113	<b>500</b>
<b>CL Switches 10 A-20 A</b> <b>C, CA and CAD Switches 10 A-315 A and L Switches 350 A-2400 A</b> C, CA and CAD switches are designed for universal application. They are recommended for instrument, isolator, double-throw and motor control. L switches are designed for load and off-load applications. They are used to switch resistive or low inductive loads.	<b>100</b>
<b>Optional Extras and Enclosures</b> The complete product line, a large number of optional extras is available, including door interlocks, push-pull devices, cylinder and padlock attachments, control and indicator devices, AC motor drives, as well as enclosures, both insulated and metal.	<b>101</b>
<b>A and AD Switches 6 A-25 A</b> A and AD switches have 4 contacts in each switching stage. These switches provide an extensive range of switch functions and require a minimum mounting depth. Up to 24 switching positions are possible, with availability of 48 contacts per 12 stage switch column.	<b>110</b>
<b>CG, CH and CHR Switches 10 A-25 A</b> Ultra compact CG, CH and CHR switches are ideally suited for control and instrumentation applications. Switch terminals are “finger-proof” and conveniently accessible for wiring and are delivered open. All CG4 switches offer specially designed gold plated contacts or H-bridges with “cross-wire” contact systems, which facilitate their use in electronic circuitry and chemically aggressive environments.	<b>120</b>
<b>DH, DHR, DK and DKR Switches 6 A-16 A</b> DH, DHR, DK and DKR switches incorporate unique corrosion resistant contacts that permit operation on system voltage as low as 1 V. They have fully enclosed and protected contacts which can be operated either by rotary and/or lateral handle movement. D switches are used in calibration and semiconductor circuits. They are also used for relay and contactor control.	<b>130</b>
<b>X Switches 200 A-630 A</b> X switches can be applied for load, tap and gang switching duties. They incorporate 6 contacts in each switching stage. Their compact design provides a minimum length dimension for mounting purposes.	<b>140</b>
<b>KG Switches 20 A-315 A and KH and KHR Switches 16 A-80 A</b> KG, KH and KHR switches are excellent circuit interruptors. They have high through fault and fault making capacities and are especially designed for use as isolators and safety switches for machine tools, distribution panels and switchboards. KG ON/OFF switches offer unusually high dimensioned air and creepage distances between terminals which are designed for time saving “straight-line” wiring. ON/OFF switches are available with up to 8 poles and double-throw switches are available with up to 4 poles.	<b>150</b>
<b>Push Buttons and Pilot Lights, 22,5 mm Ø</b> A complete range of state-of-the-art push buttons and pilot lights represent an ideal combination of functional security and economical efficiency in a modular design.	<b>302</b>

---

We reserve the right to make technical and dimensional changes without prior notice.

### Australia

Kraus & Naimer Pty. Ltd.  
379 Liverpool Road, ASHFIELD, N.S.W. 2131  
P: 1800 567 948  
E: sales-au@krausnaimer.com

### Austria

Kraus & Naimer GmbH  
Schumannngasse 39  
1180 WIEN  
P: +43 1 404 06 0  
E: sales-at@krausnaimer.com

### Belgium, Luxembourg

Kraus & Naimer B.V.  
Ikaros Business Park  
Ikaroslaan 2  
1930 ZAVENTHEM  
P: +32 2 757 0141  
F: +32 2 757 1640  
E: sales-be@krausnaimer.com

### Brazil

Central and South America  
Kraus & Naimer Ind. Com. Ltda.  
Rua Santa Monica, 1061  
Parque Industrial San Jose  
P: +55 11 2198 1288  
F: +55 11 2198 1251  
E: knbrasil@krausnaimer.com.br

### Canada

Kraus & Naimer Ltd.  
219 Connie Crescent, Unit 13A  
CONCORD, Ontario, L4K 1L4  
P: +1 905 738 1666  
E: sales-ca@krausnaimer.com

### Cyprus

ELECTROMATIC CONSTRUCTIONS LTD.  
72, Evagoras Pallikarides Str., 2235 LATSIA-Nicosia  
P. O. Box 12630, 2251 LATSIA-Nicosia  
P: +357 2 48 41 41  
F: +357 2 48 57 47  
E: electromatic@cytanet.com.cy

### Czech Republic

OBZOR, výrobní družstvo Zlín  
Na Slanici 378  
763 02 ZLÍN  
P: +420 577 195 150  
F: +420 577 195 152  
E: odbyt@obzor.cz

### Denmark

THIIM A/S  
Transformervej 31  
2860 SOEBORG  
P: +45 4485 8000  
F: +45 4485 8005  
E: thiim@thiim.com

### Finland

Kraus & Naimer Oy  
Kiitoradankuja 8  
01530 VANTAA  
P: +358 9 825 424 0  
E: sales-fi@krausnaimer.com

### France

Kraus & Naimer s.a.s.  
33, rue Bobillot  
75013 PARIS  
P: +33 1 58 40 80 80  
E: sales-fr@krausnaimer.com

### Germany

Kraus & Naimer GmbH  
Wikingerstraße 20-28, 76189 KARLSRUHE  
Postfach 10 01 24, 76231 KARLSRUHE  
P: +49 721 59 88 0  
E: sales-de@krausnaimer.com

### Great Britain

Kraus & Naimer Ltd.  
115 London Road  
NEWBURY/BERKSHIRE RG14 2AH  
P: +44 1635 262626  
F: +44 1635 37807  
E: sales-uk@krausnaimer.com

### Greece

KALAMARAKIS-SAPOUNAS S. A.  
Ionias & Neromilou Str., P. O. Box 46566  
13671 ACHARNES/ATHENS  
P: +30 2 10 240 6000 6  
F: +30 2 10 240 6007  
E: kalamarakis.sapounas@ksa.gr

### Hungary

GANZ KK KFT.  
X. Kőbányai út 41/c, Postfach 87  
1475 BUDAPEST  
P: +36 1 261 5479  
E: ganzkk@ganzkk.hu

### Iceland

JOHAN RÖNNING LTD.  
Klettgarðar 25  
104 REYKJAVÍK  
P: +354 5200 800  
E: ronning@ronning.is

### Republic of Ireland

Kraus & Naimer Ltd.  
4235 Atlantic Avenue  
Westpark Business Campus  
Shannon, Co. Clare  
P: +353 61 704700  
F: +353 61 471084  
E: sales-ie@krausnaimer.com

### Italy

Kraus & Naimer s.r.l.  
Via Terracini, 9  
24047 TREVIGLIO (BG)  
P: +39 0363 30 11 12  
E: sales-it@krausnaimer.com

### Japan

Kraus & Naimer Ltd.  
Yoshiwada Building 2F  
1-11-6 Hamamatsucho  
Minato-Ku, TOKYO 105-0013  
P: +81 3 3436 6151  
F: +81 3 3436 6325  
E: sales-jp@krausnaimer.com

### Mexico

JC INGENIERÍA Y CONTROL, SA DE CV.  
Ángel Gavilño 30.  
C. Satélite, C. Medicos,  
Naucalpan Edo. de Mexico, C.P. 53100  
P: +52 55 55 62 75 77  
F: +52 55 55 62 04 34  
E: ventas@jcingenieriacontrol.com

### Netherlands

Kraus & Naimer B.V.  
Wegtersweg 38-40, Postbus 199  
7556 BR HENGEL0 (Ov.)  
P: +31 74 291 9441  
F: +31 74 291 98380  
E: sales-nl@krausnaimer.com

### New Zealand

Kraus & Naimer Ltd.  
42 Miramar Avenue, WELLINGTON 6022  
P. O. Box 15-009, WELLINGTON 6243  
P: + 64 0800 736 522  
E: sales-nz@krausnaimer.com

### Norway

Kraus & Naimer AB Avd. Norge  
Postboks 27 Vollebekk  
0516 Oslo  
P: +47 22 64 44 20  
E: sales-no@krausnaimer.com

### Poland

ASTAT LOGISTYKA SP. Z O.O.  
Dąbrowskiego 441  
60451 POZNAŃ  
P: +48 61 849 80 89  
E: k.swiderski@astat.pl

### Portugal

ELECTRICOL-DAMAS, FERREIRA & DAMASCENO, LDA.  
Apartado 1063, S. Ant. Cavaleiros  
2670 LOURES  
P: +351 21 989 8939  
F: +351 21 988 6464  
E: electrical@electricol.pt

### Singapore, India, Middle East – UAE

Kraus & Naimer Pte. Ltd.  
115A, Commonwealth Drive  
#03-17/23  
SINGAPORE 149 596  
P: +65 6473 8166  
E: sales-sg@krausnaimer.com

### Slovenia

SCHRACK TECHNIK D.O.O.  
Pameče 175  
SI-2380 SLOVENJ GRADEC  
P: +386 2 88 392 00  
F: +386 2 88 434 71  
E: d.goljat@schrack.si

### Republic of South Africa

Kraus & Naimer Pty. Ltd.  
7 Village Crescent, Linbro Village  
Linbro Business Park, SANDTON 2065  
P. O. Box 511, KELVIN 2054  
P: +27 11 608 6060  
E: sales-za@krausnaimer.com

### Spain

Kraus & Naimer B.V.  
P: +34 662 696 014  
E: sales-es@krausnaimer.com

### Sweden

Kraus & Naimer AB  
Dr. Widerströms Gata 11, Hägersten  
Box 42097, 126 14 STOCKHOLM  
P: +46 8 97 00 80  
E: sales-se@krausnaimer.com

### Switzerland

AWAG Elektrotechnik AG  
Sandbühlstraße 2  
CH-8604 VOLKETSCHWIL  
P: +41 44 908 19 19  
E: info@awag.ch

### Turkey

KARDES ELEKTRİK SANAYİ VE TİCARET A.Ş.  
Yassıoren Mah. Hıfıa Sok. No: 4  
34277 Arnavutköy-Istanbul-Turkey  
P: +90 212 624 92 04 118  
F: +90 212 592 48 10  
E: info@unalkardes.com.tr

### USA

Kraus & Naimer Inc.  
760 New Brunswick Road  
SOMERSET, NJ 08873  
P: +1 732 560 1240  
E: sales-us@krausnaimer.com



Kraus & Naimer

---



---

**Contact us:**

[www.krausnaimer.com](http://www.krausnaimer.com)